

doorson



We keep people moving

AUTOMATIC SLIDING DOORS

doorson

We create
automatic sliding doors,
energy efficiency,
human safety &
stylish design.





We keep people moving



30

years of tradition

60

employees

EU

made

Our products include

70%

saving energy
and reducing CO²

30

countries

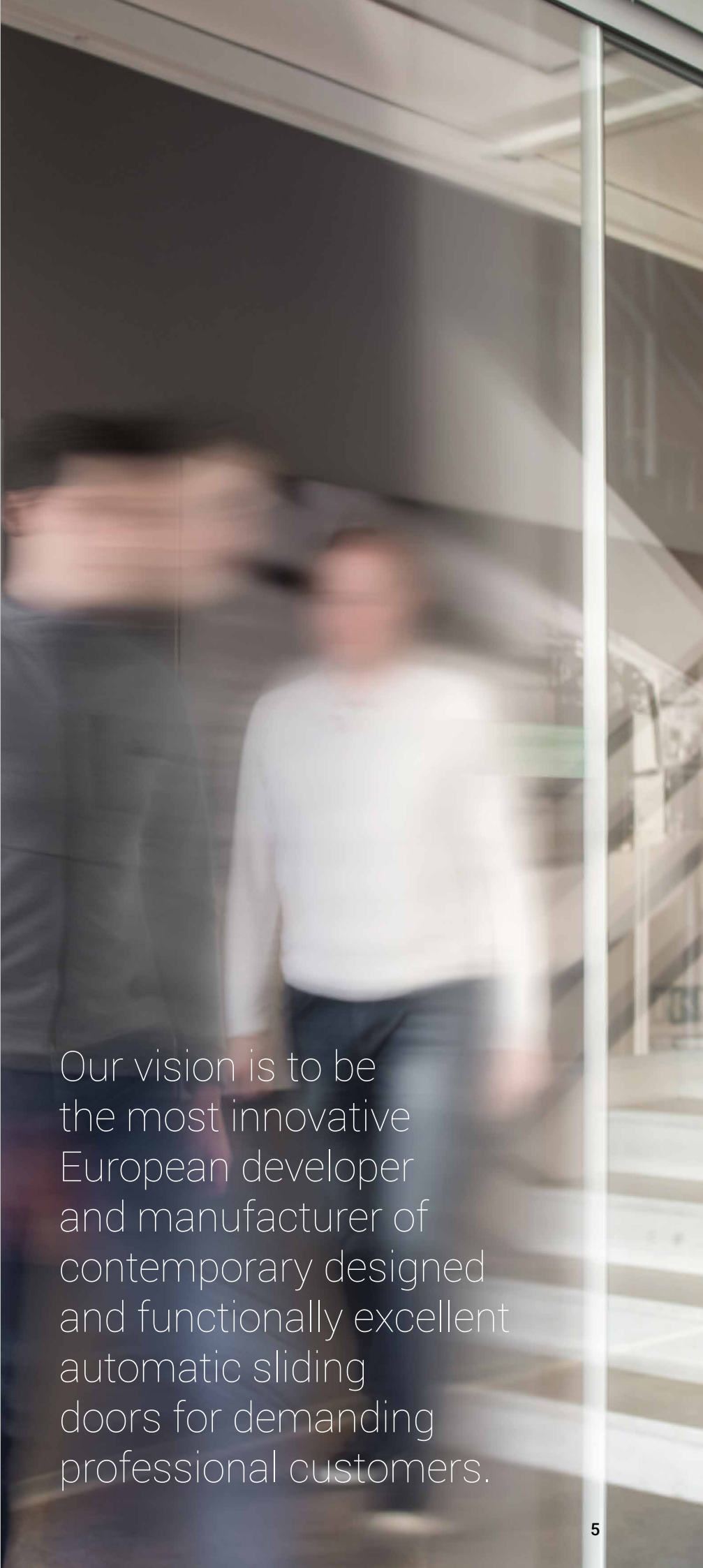

Our vision is to be the most innovative European developer and manufacturer of contemporary designed and functionally excellent automatic sliding doors for demanding professional customers.

Automatic sliding doors are our passion





Knowledge, passion and history combined are the foundation of Doorson. Having our own development, technology and production allows us to create unique door solutions. We develop advanced solutions by means of innovative technologies. Our main focus is to integrate design in every detail.

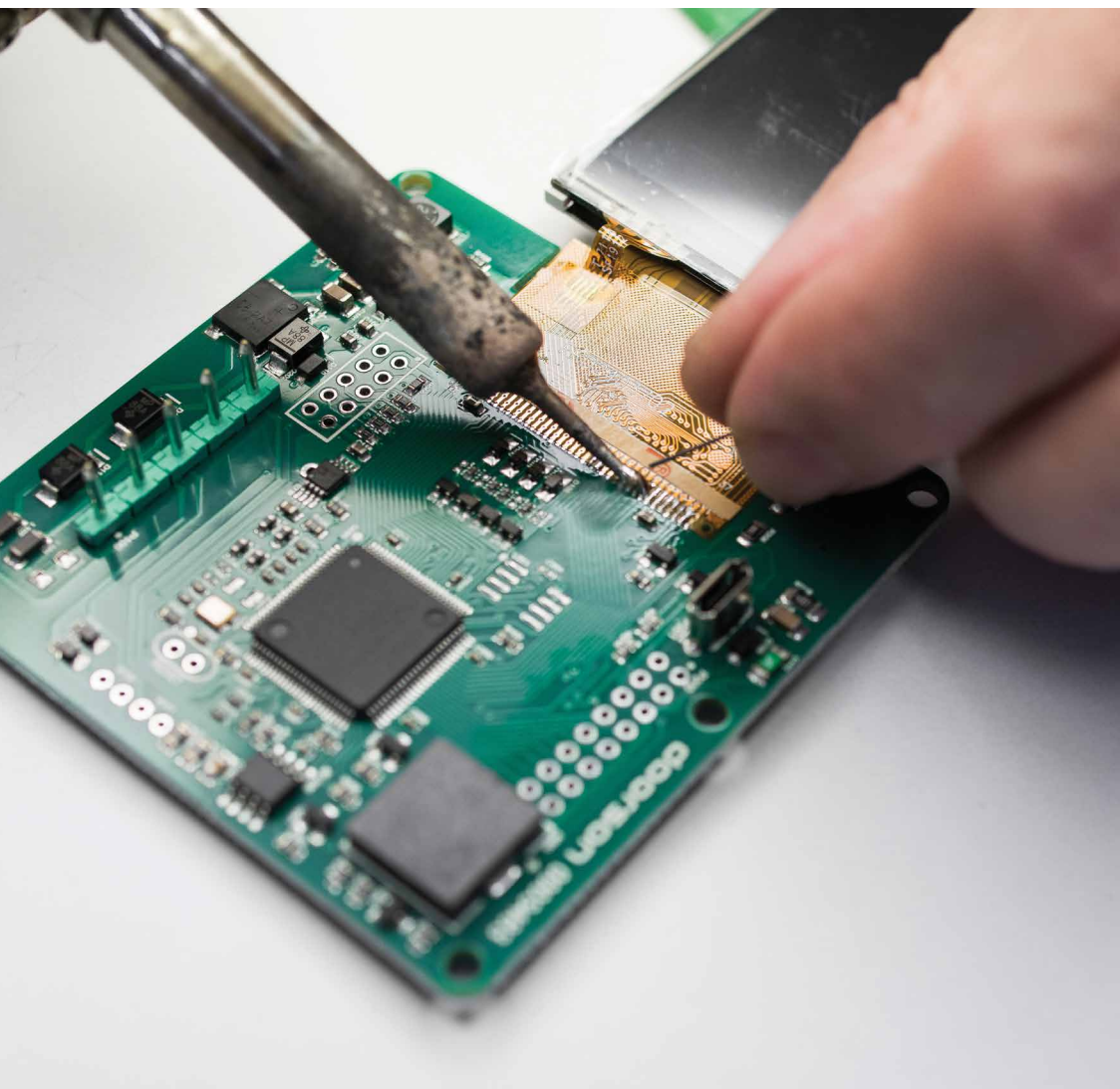



We live in an online world. For fast, accurate and effective performance we connect with our partners by creating different online tools such as Door Calculator, Door Service and Door Base, which improve your experience.

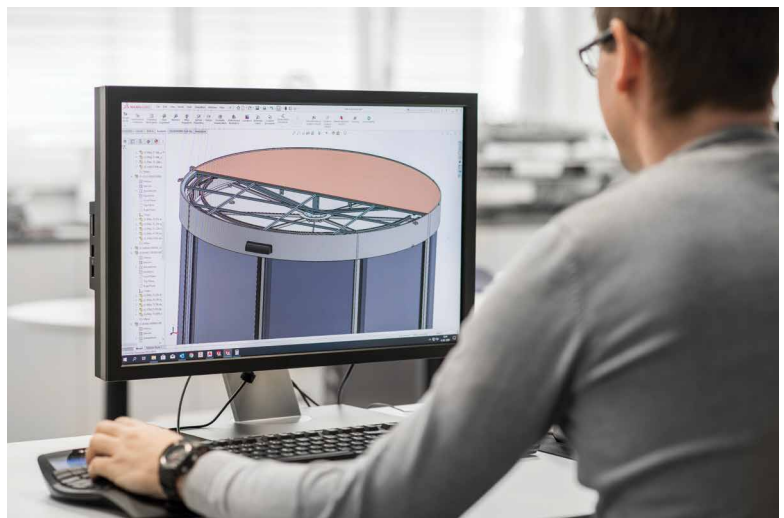

We are building strong relationships with our clients around the globe. Development, production, installation, technical support and understanding our clients' needs is all part of our door technology. For us, a good partnership is the bridge to success.

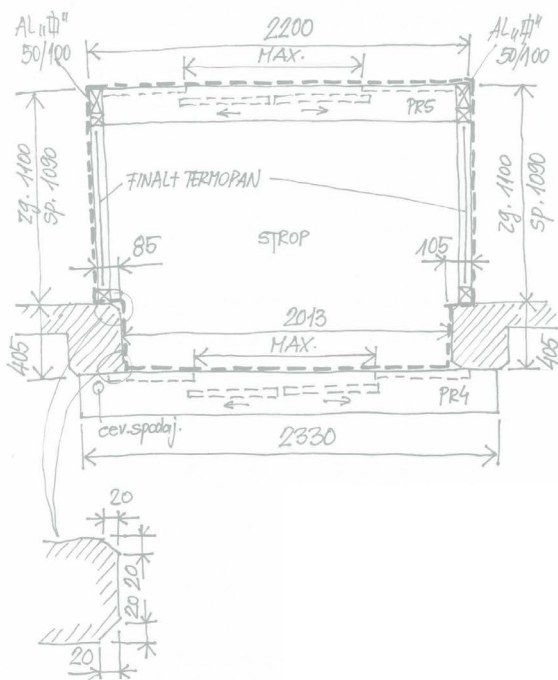



We are aware that Doorson is much more than production of automatic sliding doors for the market; we behave as creators and specialists for custom door solutions made for end users, architects and our door partners.

Table of contents

16	PRODUCT LINE 300
28	300 thales
34	300
40	300 T
46	300 A
52	300 P
58	300 C
68	PRODUCT LINE 400
78	400 thales
86	400 fusion
94	400 timber
106	PRODUCT LINE 500
116	500 F
122	500 EF
128	500 EFS
144	ADDITIONAL INFORMATION
146	Door switches
148	Touchless opening
150	Remote control
152	Save energy
154	Escape routes
156	Digital transformation
158	Door Calculator
160	Service, maintenance & support
162	REFERENCE PROJECTS

Enter **Doorson product range** —→

300

Open your space



doorson_STANDARD



Highly efficient and attractively designed automatic sliding doors for any application.

→ 016

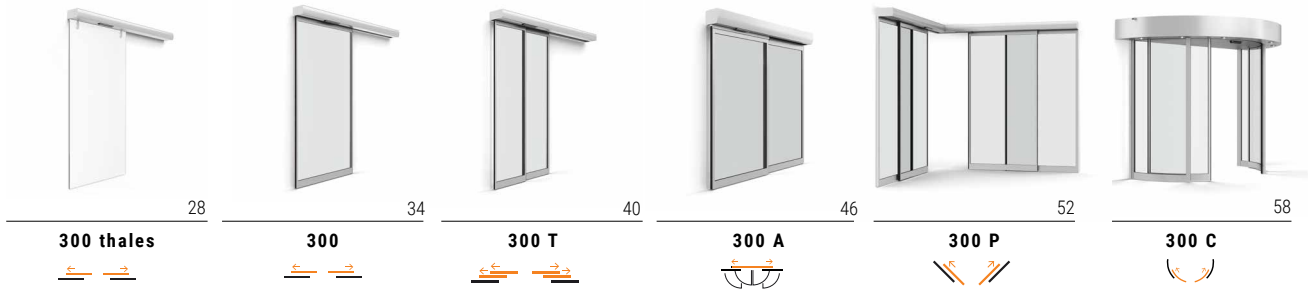

330

LAUNCH 2021

Energy-efficient performance



doorson_STANDARD



Automatic sliding doors for glazing facade entrances. Thermally broken profiles system with triple glazing thermopan that results in high energy-passive efficiency.

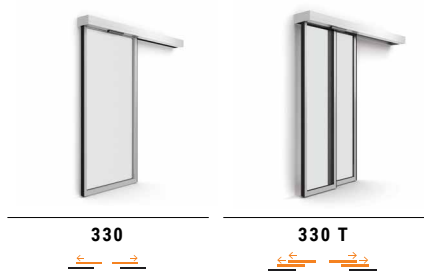

400

NEW

Stylish design & functionalities

doorson_INTERIOR



The perfect mix of design and functionality. Slim line interior automatic sliding doors that bring out the best in architectural designs.

→ 068



78

400 thales



86

400 fusion



94

400 timber



500

NEW

On the safe side of fire

doorson_FIRE



Fire automatic sliding door with the comfort of sliding door access. In case of an emergency, the door ensures fire safety as well as a safe escape and rescue route.

→ 106

Fire resistance EI30/EI60



116

500 F



122

500 EF



128

500 EFS





300_ product line

Open your space

Highly efficient and attractively designed automatic sliding doors product line 300 for exterior and interior. They provide a variety of architectural possibilities when designing an office, hotel, restaurant, hospital or any other place. The only limit is your imagination.

Product line 300 and its modern 10 cm drive integrate into every building and meet the needs of even the most demanding users. Stylish, efficient and easy to use.





Design & functionality

Details make all the difference



The slim, minimalistic 10 cm drive is less intrusive and gives the door a modern look. The built-in sensor ensures a comfortable and safe entrance. The door is operated by our innovative drive controller with our very own door switches that offer various functions.

Since our automatic sliding doors consume less than 0.5 W of electricity when they are in sleep mode, you don't only cut your costs, but also contribute to a cleaner environment by using our energy-saving doors.

Product line 300 increases the security level and enables a safe and easy emergency exit for everyone.

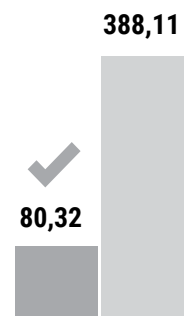

10 cm
drive height

built-in
sensor
for pedestrian safety

< 0.5 W
power consumption

70%
saving energy
and reducing CO²



ACCESS

Provide a comfortable, safe and secure access for everybody.



MOBILE CONTROL

The easiest way to control your door from anywhere and anytime.



DIAGNOSTICS

Warnings and errors description.



DOOR CLOUD

Doors are connected to the cloud. Solve your problem remotely.

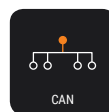

CAN

Door controller is CAN connected with sensors, switches and smart devices.



SAFETY OPERATION

Advanced security becomes possible with advanced technology. Your safety is our highest priority.



SAFE EXIT

Safe evacuation in case of an emergency.

Heavily used entrances

Fast mobility

No need to worry about how you will open the door when your hands are full. An automatic entrance allows for free movement for when your hands are taken up carrying things, for shopping trolleys and for people with reduced mobility. They are made for high frequency entrances and, moreover, they are friendly, elegant and practical.



0.3 - 0.7 m/s
open/close

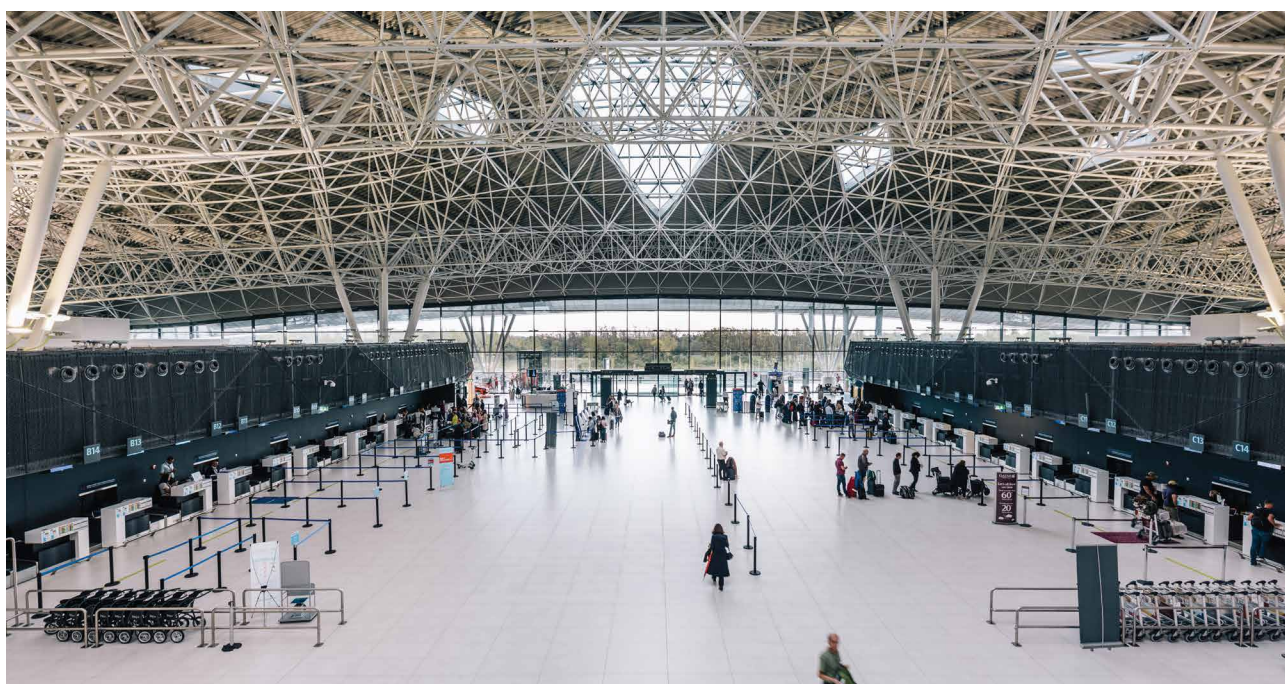



Advanced solutions

First impression begins at the front door

Make sure to make the best first impression when your guests enter your building. The main entrance to your space should look welcoming from the outside in order to make a positive impression on the person who walks through the front door. When you integrate a glass door into a building you brighten and open up the entire space.



custom
design
you choose the image



Restaurant and hospitality

Think about the service, not the doors

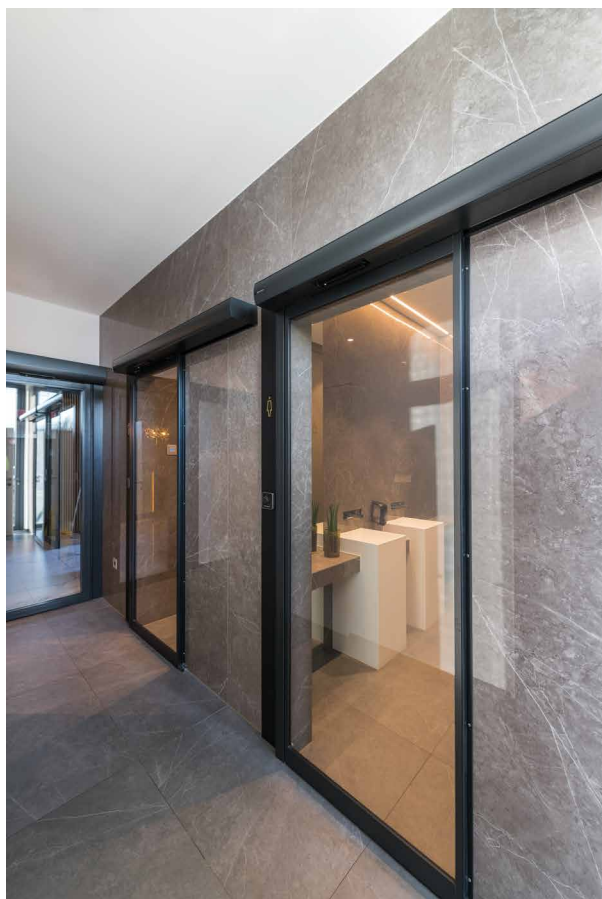

Restaurants are a busy place and the staff is there to make the customers happy. However, this is hard to do when your hands are full and you have to worry about opening the door. Doorson's doors make their job easier with an automatic door opening.

Easy for the staff and your guests.

touchless
door opening



Healthcare

Touchless opening and clean hands

In healthcare environments everything matters. Doorson ensures that everybody in your building can move quickly, efficiently and safely. Besides the health and comfort of the patients, hygiene is the top priority. With an automatic and hands-free opening - closing we increase the level of hygiene. When the room is equipped with a control system, only authorized persons can enter. Privacy and security are guaranteed.



100%
hands-free access





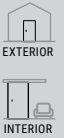

Product range 300_

Doors for every need

From standard products to custom-made solutions, product line 300 has a very wide range of applications. The versatility of the doors makes them a perfect solution for different situations.

Product line 300 fulfills the essential requirements in the applicable CE directives and is available with the redundant function, which allows it to be installed on emergency exits and escape routes, according to the EN 16005 and EN 16361 standards.



28

300 thales | frameless sliding door
Virtually invisible

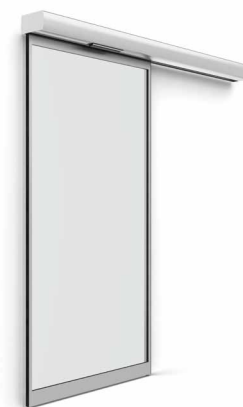

34

300 | standard sliding door
The universal choice



40

300 T | telescopic sliding door
Open wider



46

300 A | break-out sliding door
Safe open



52

300 P | prismatic sliding door
Inspiration on the corner



58

300 C | curved sliding door
Great first impression





Virtually invisible

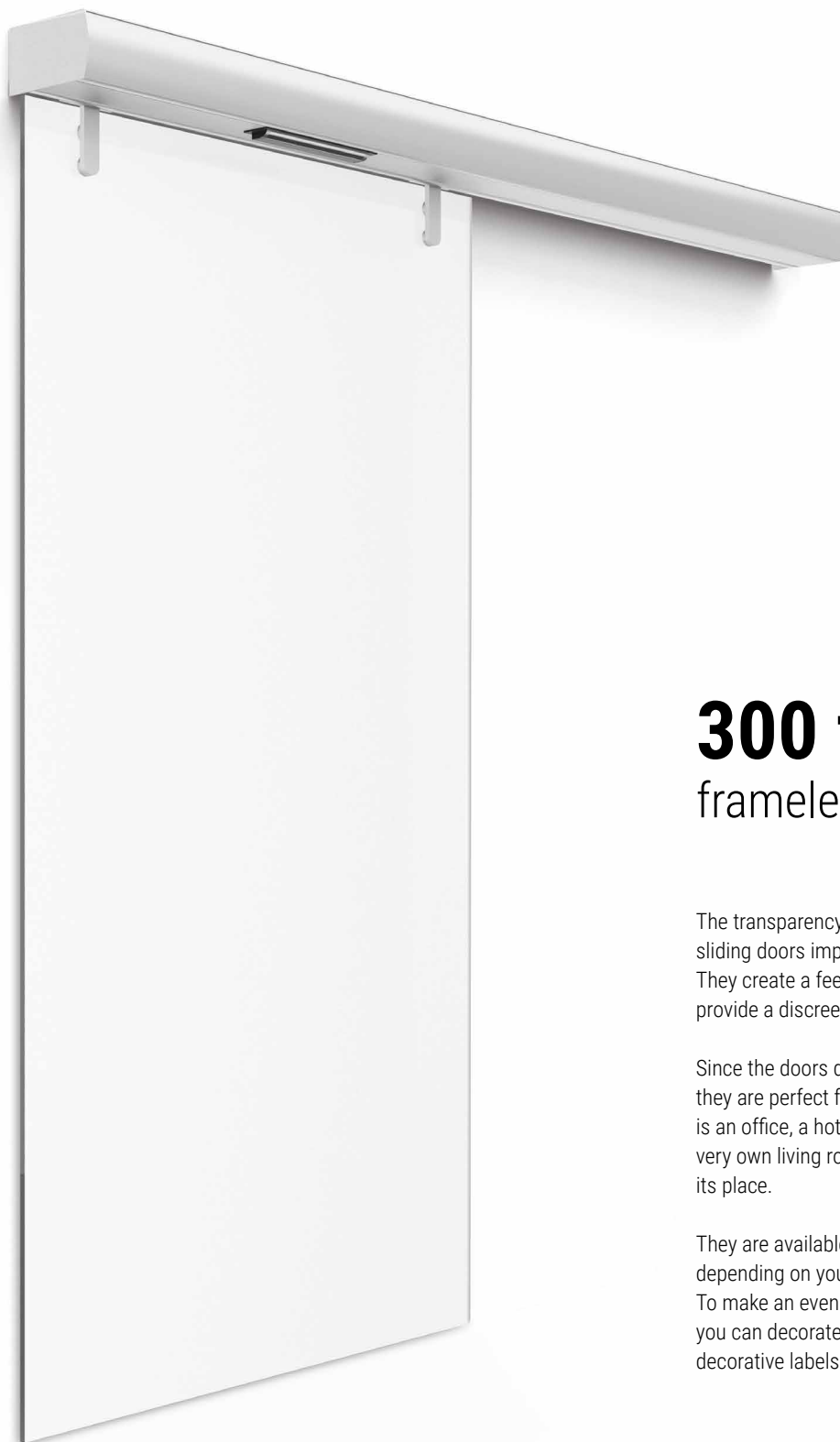

300 thales | frameless sliding door

The transparency and simplicity of thales sliding doors impresses at first glance. They create a feeling of an open space and provide a discreet view at the same time.

Since the doors do not have vertical profiles, they are perfect for any interior. Whether it is an office, a hotel lobby, restaurant or your very own living room, thales will always find its place.

They are available in printed or matt glass, depending on your wishes and project. To make an even better first impression, you can decorate your doors with different decorative labels.









Technical data | 300 thales

USE	interior
DRIVE	height: 100 mm
DIMENSIONS	1 leaf: clear opening width 800 - 2000 mm clear opening height 1900 - 3000 mm 2 leaves: clear opening width 800 - 3000 mm clear opening height 1900 - 3000 mm
WEIGHT	max. 100 kg per sliding leaf
OPENING - CLOSING SPEED	0.3 - 0.7 m/s (adjustable)
OPENING TIME	0 - 60 s (adjustable)
POWER CONSUMPTION	max 300W/230V < 0.5W power consumption in sleeping mode
LEAF	float
INSTALLATION	wall installation, between the wall, under the ceiling, with top screen, in the wall
PROFILE COLOR	anodized aluminium: natural RAL color
GLASS COLOR	different color options
DOOR OPENING	sensor, switches, smartphone, access control
FUNCTIONALITY	a variety of adjustable functions and parameters switching between different door regimes: OPEN, LOCK, STOP, AUTO-SUMMER, AUTO-WINTER, ONE WAY-SUMMER, ONE WAY-WINTER warning diagnosis by COM20
ENERGY SAVING	✓
EMERGENCY EXIT	✓
BATTERY	included
ELECTRIC LOCK	included
STANDARDS	EN 16005, EN 16361

1L / 1S 	FW = 800 - 2000 mm FH = 1900 - 3000 mm COW = 800 - 2000 mm COH = 1900 - 3000 mm UX = 1670 - 6500 mm X min = 10 mm
2L / 2S 	FW = 800 - 3000 mm FH = 1900 - 3000 mm COW = 800 - 3000 mm COH = 1900 - 3000 mm UX = 1600 - 6500 mm X min = 10 mm



* S = sliding leaf, L = leaf, FW = frame width, FH = frame height, COW = clear opening width, COH = clear opening height, UW = Unit width, X = distance



300 thales | float 2L/2S on the wall

Vertical section view

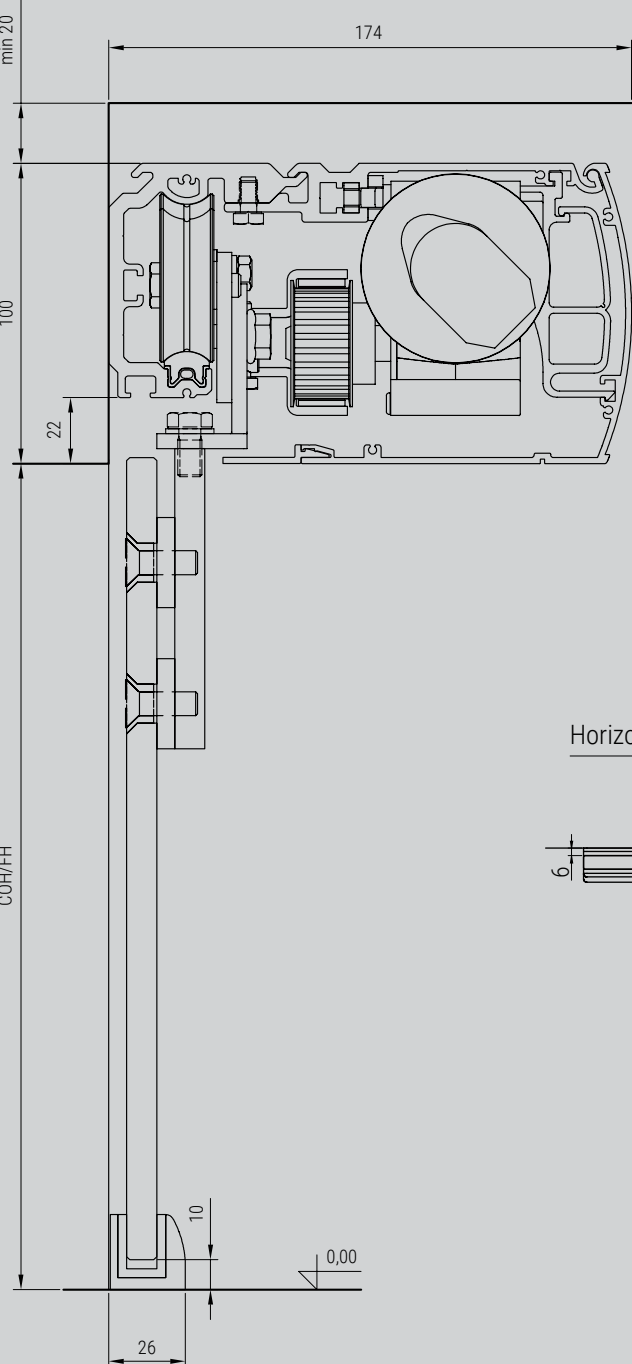

Front view

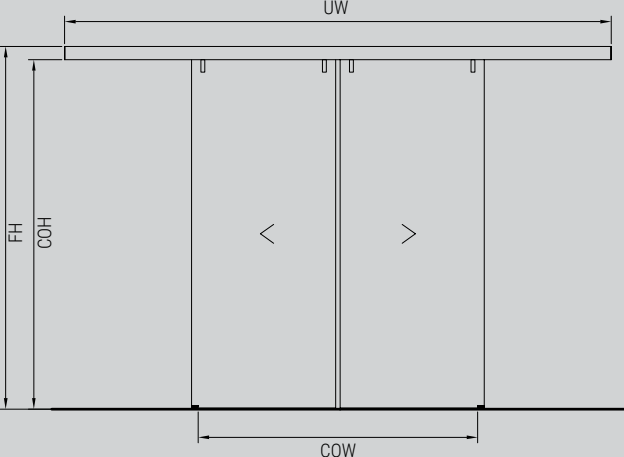

Horizontal section view

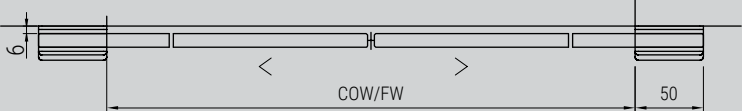

The universal choice



300 | standard sliding door

You can use standard sliding doors anywhere. Their flexibility and functionality make each project completely unique and are always an excellent solution.

A universal choice, perfect for both interior and exterior. Extremely appropriate for highly frequent entrances, since they allow a smooth flow of all users.

The possibility of using different profile colors allows you to create a project that suits your desires.

They are assembled with door switches, they are easy to use and they provide additional functionalities.





PLAZA RESTAURANT





Camp Šobec



Hotel A | architecture: Arhitektura AB objekt

Technical data | 300

USE	interior/exterior
DRIVE	height: 100 mm
DIMENSIONS	1 leaf: clear opening width 800 - 2000 mm clear opening height 1900 - 3000 mm 2 leaves: clear opening width 800 - 3000 mm clear opening height 1900 - 3000 mm
WEIGHT	PR4: max. 120 kg per sliding leaf PR5: max. 160 kg per sliding leaf
OPENING - CLOSING SPEED	0.3 - 0.7 m/s (adjustable)
OPENING TIME	0 - 60 s (adjustable)
POWER CONSUMPTION	max 300W/230V < 0.5W power consumption in sleeping mode
LEAF	float, thermo, panel
INSTALLATION	wall installation, between the wall, under the ceiling, with top screen, in the wall
PROFILE COLOR	anodized aluminium: natural RAL color
GLASS COLOR	different color options
DOOR OPENING	sensor, switches, smartphone, access control
FUNCTIONALITY	a variety of adjustable functions and parameters switching between different door regimes: OPEN, LOCK, STOP, AUTO-SUMMER, AUTO-WINTER, ONE WAY-SUMMER, ONE WAY-WINTER warning diagnosis by COM20
ENERGY SAVING	✓
EMERGENCY EXIT	✓
BATTERY	included
ELECTRIC LOCK	included
STANDARDS	EN 16005, EN 16361

1L / 1S	FW = 800 - 2000 mm FH = 1900 - 3000 mm COW = 800 - 2000 mm COH = 1900 - 3000 mm UX = 1670 - 6500 mm X min = 10 mm	2L / 2S	FW = 800 - 3000 mm FH = 1900 - 3000 mm COW = 800 - 3000 mm COH = 1900 - 3000 mm UX = 1600 - 6500 mm X min = 10 mm
2L / 1S	FW = 1600 - 6500 mm FH = 1900 - 3000 mm COW = 800 - 2000 mm COH = 1900 - 3000 mm UX = 1670 - 6500 mm X min = 30 mm	4L / 2S	FW = 1800 - 6500 mm FH = 1900 - 3000 mm COW = 800 - 3000 mm COH = 1900 - 3000 mm UX = 1800 - 6500 mm X min = 10 mm

* S = sliding leaf, L = leaf, FW = frame width, FH = frame height, COW = clear opening width, COH = clear opening height, UW = Unit width, X = distance



300 | float 2L/2S on the wall

Front view

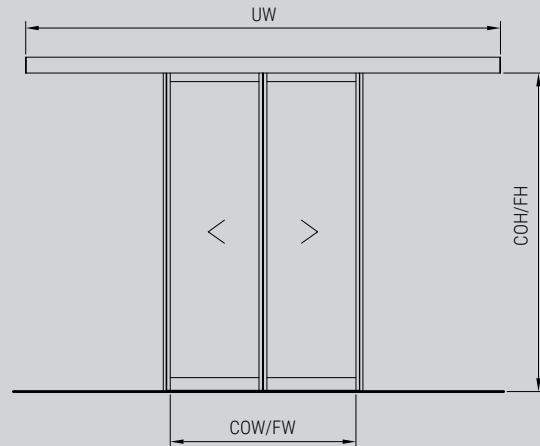

Vertical section view

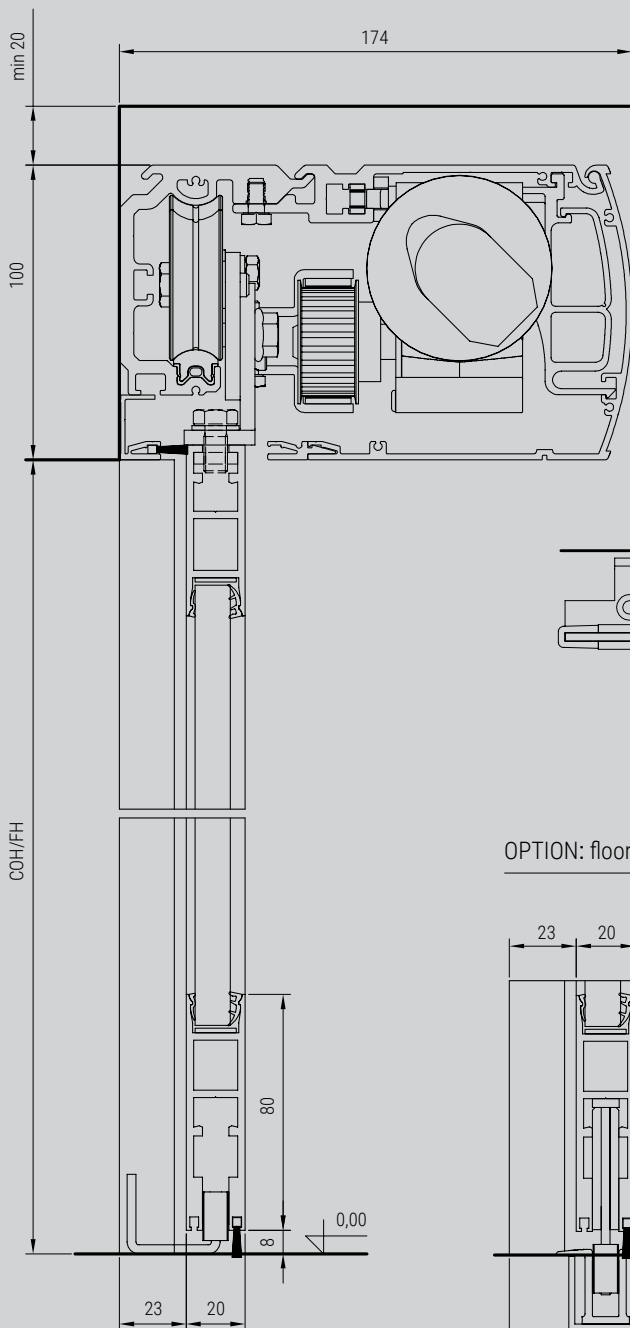

Horizontal section view

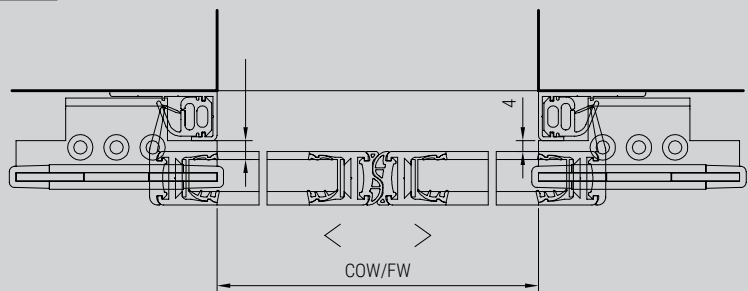

OPTION: floor slider lead

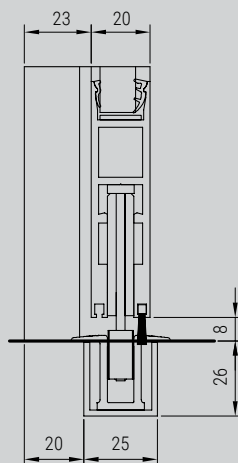

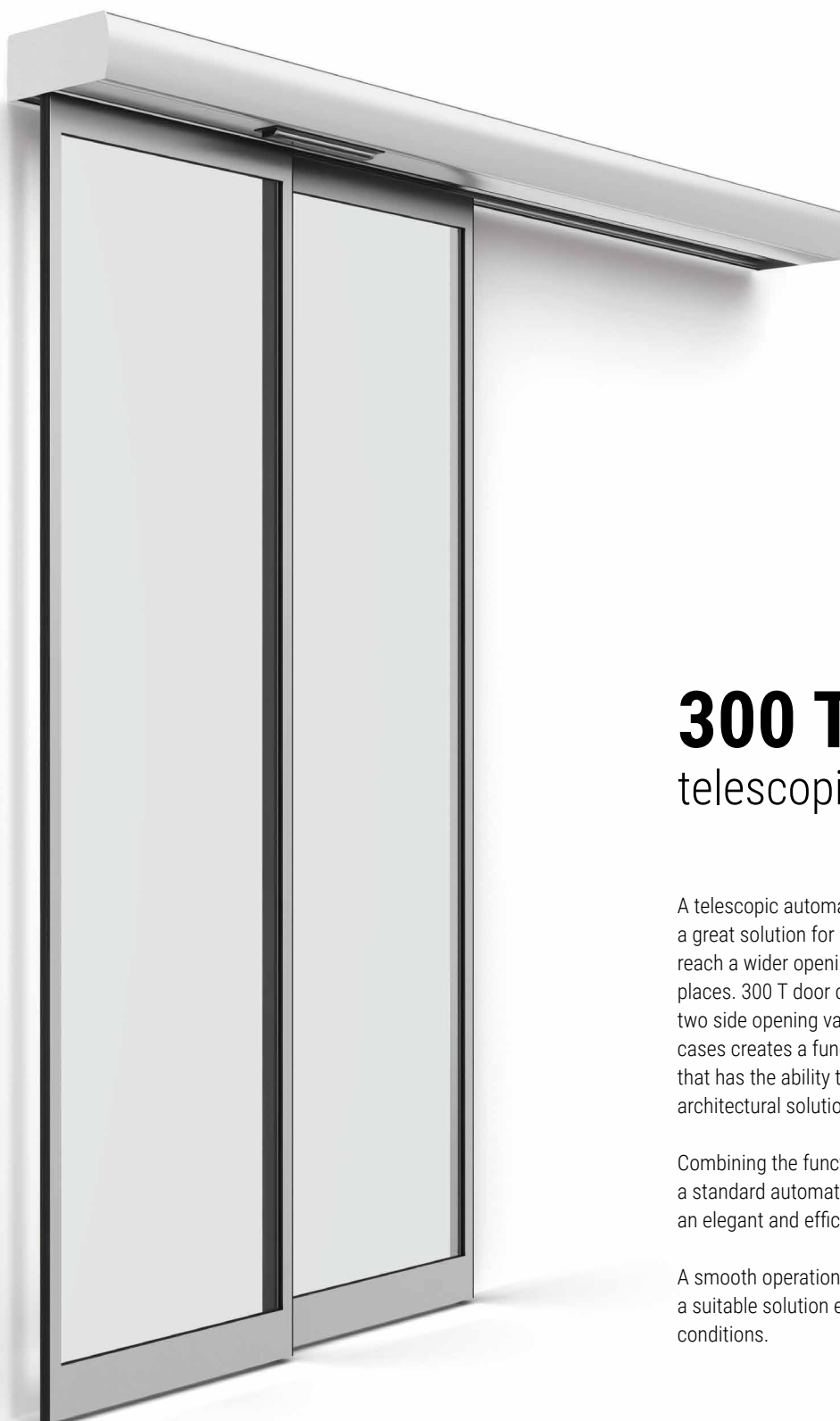
Open wider

300 T | telescopic sliding door

A telescopic automatic sliding door is a great solution for limited spaces. It can reach a wider opening even in the narrowest places. 300 T door comes in a one or two side opening variation, which in both cases creates a functional wide entrance that has the ability to adapt to any special architectural solution.

Combining the functionality and design of a standard automatic door, 300 T provides an elegant and efficient entrance.

A smooth operation that saves space and is a suitable solution even for the most limited conditions.









EXPANO | architecture: SoNo Architects



Beeland Skok Mozirje

Technical data | 300 T

USE	interior/exterior
DRIVE	height: 100 mm
DIMENSIONS	One sided: clear opening width 900 - 3000 mm clear opening height 1900 - 3000 mm Two sided: clear opening width 1600 - 3000 mm clear opening height 1900 - 3000 mm
WEIGHT	PR4: max. 2 x 112 kg or 4 x 56 kg PR5: max. 2 x 135 kg or 4 x 67 kg
OPENING - CLOSING SPEED	0.3 - 0.7 m/s (adjustable)
OPENING TIME	0 - 60 s (adjustable)
POWER CONSUMPTION	max 300W/230V < 0.5W power consumption in sleeping mode
LEAF	float, thermo, panel
INSTALLATION	wall installation, between the wall, under the ceiling, with top screen, in the wall
PROFILE COLOR	anodized aluminium: natural RAL color
GLASS COLOR	different color options
DOOR OPENING	sensor, switches, smartphone, access control
FUNCTIONALITY	a variety of adjustable functions and parameters switching between different door regimes: OPEN, LOCK, STOP, AUTO-SUMMER, AUTO-WINTER, ONE WAY-SUMMER, ONE WAY-WINTER warning diagnosis by COM20
ENERGY SAVING	✓
EMERGENCY EXIT	✓
BATTERY	included
ELECTRIC LOCK	included
STANDARDS	EN 16005, EN 16361

2L / 2S	FW = 900 - 3000 mm FH = 1900 - 3000 mm COW = 900 - 3000 mm COH = 1900 - 3000 mm UX = 1400 - 6500 mm X min = 55 mm	4L / 4S	FW = 1600 - 3000 mm FH = 1900 - 3000 mm COW = 1600 - 3000 mm COH = 1900 - 3000 mm UX = 2500 - 6500 mm X min = 55 mm
3L / 2S	FW = 1400 - 6500 mm FH = 1900 - 3000 mm COW = 900 - 3000 mm COH = 1900 - 3000 mm UX = 1400 - 6500 mm X min = 55 mm	6L / 4S	FW = 1800 - 6500 mm FH = 1900 - 3000 mm COW = 1600 - 3000 mm COH = 1900 - 3000 mm UX = 1800 - 6500 mm X min = 55 mm

* S = sliding leaf, L = leaf, FW = frame width, FH = frame height, COW = clear opening width, COH = clear opening height, UW = Unit width, X = distance



300 T | thermo 2L/2S on the wall

Front view

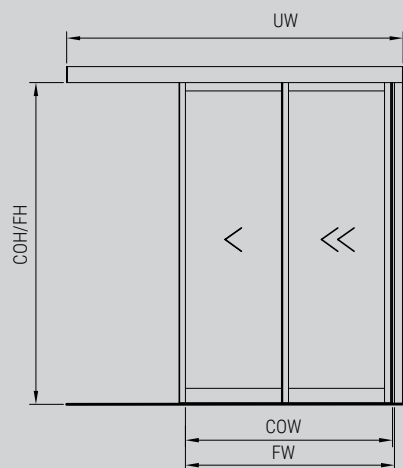

Vertical section view

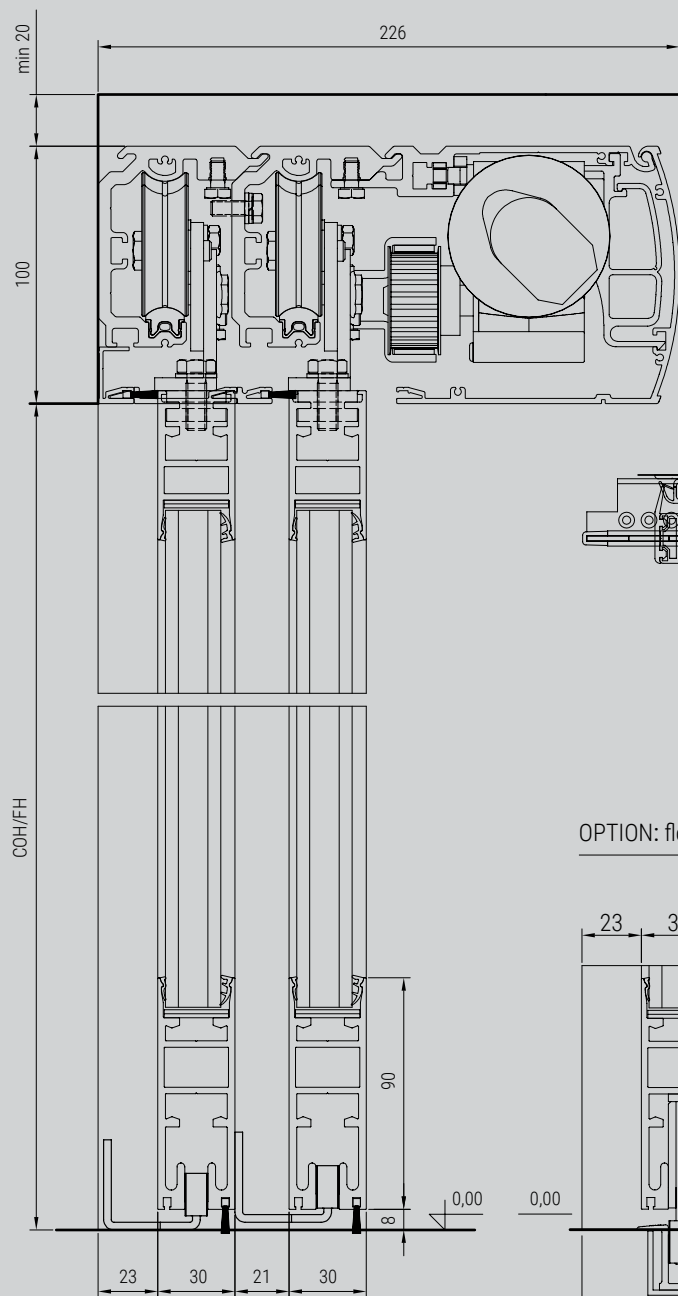

Horizontal section view

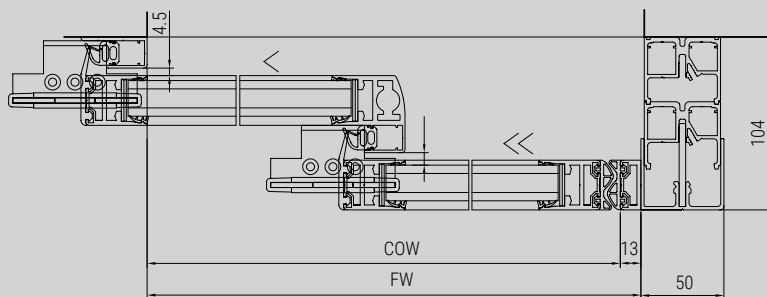

OPTION: floor slider lead

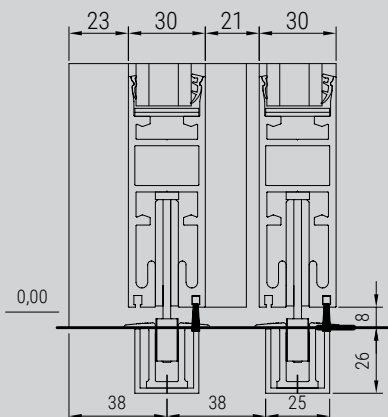

Safe open

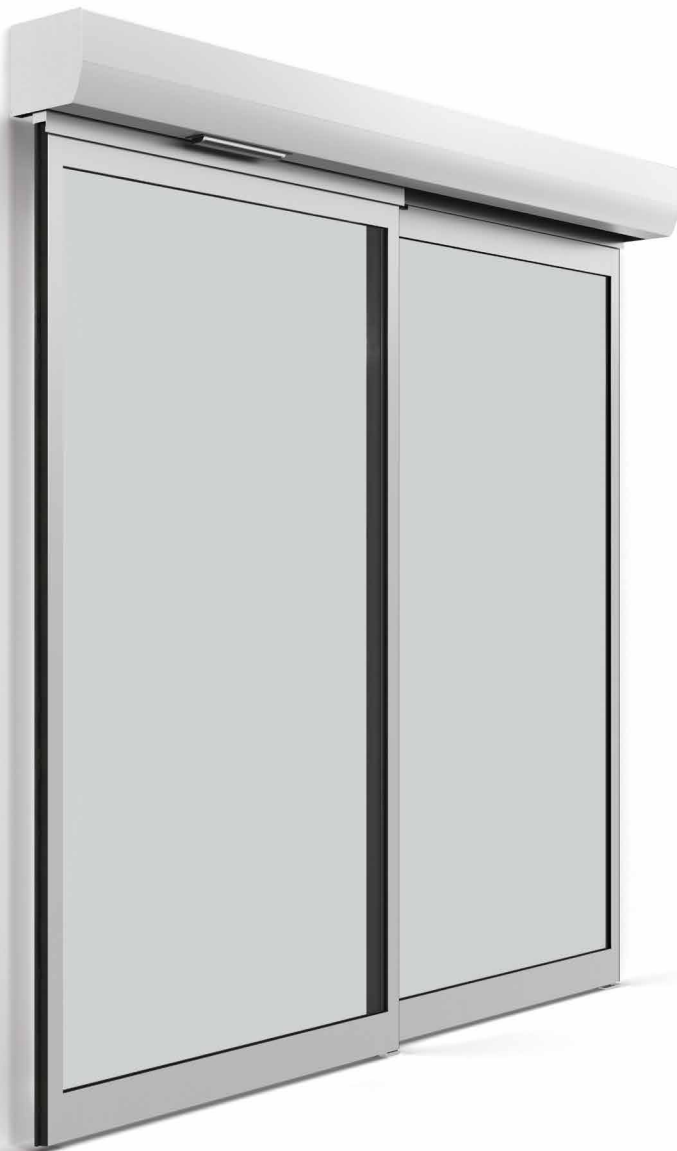

300 A | break-out sliding door

In everyday situations 300 A functions as a standard automatic sliding door, which enables people to efficiently move through frequently used entrances.

They are an excellent choice for buildings that occasionally need a full-width opening, like furniture stores or car dealerships.

Their special feature is in their break-out leaves. In case of an emergency, you have to press on the leaves in order for the break-out to open. A swing door opening provides a safe rescue route out of the building.

300 A is multi-functional, easy to use and highly safe. A perfect solution for many different cases.

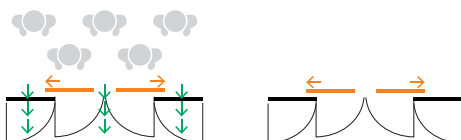







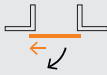
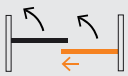

Technical data | 300 A

USE	interior/exterior
DRIVE	height: 170 mm
DIMENSIONS	1 leaf: clear opening width 800 - 1200 mm clear opening height 1900 - 3000 mm 2 leaves: clear opening width 800 - 2200 mm clear opening height 1900 - 3000 mm
WEIGHT	max. 90 kg per sliding leaf, max. 125 kg per fixed leaf
OPENING - CLOSING SPEED	0.3 - 0.7 m/s (adjustable)
OPENING TIME	0 - 60 s (adjustable)
POWER CONSUMPTION	max 300W/230V < 0.5W power consumption in sleeping mode
LEAF	thermo, panel
INSTALLATION	wall installation, between the wall, under the ceiling, with top screen, in the wall
PROFILE COLOR	anodized aluminium: natural RAL color
GLASS COLOR	different color options
DOOR OPENING	sensor, switches, smartphone, access control
FUNCTIONALITY	a variety of adjustable functions and parameters switching between different door regimes: OPEN, LOCK, STOP, AUTO-SUMMER, AUTO-WINTER, ONE WAY-SUMMER, ONE WAY-WINTER warning diagnosis by COM20
ENERGY SAVING	✓
EMERGENCY EXIT	✓
BATTERY	included
ELECTRIC LOCK	included
STANDARDS	EN 16005, EN 16361

1L / 1S / 1A 	FW = 800 - 1200 mm FH = 1900 - 3000 mm COW = 800 - 1200 mm COH = 1900 - 3000 mm UX = 1800 - 3000 mm X min = 10 mm
2L / 1S / 2A 	FW = 1800 - 3000 mm FH = 1900 - 3000 mm COW = 800 - 1200 mm COH = 1900 - 3000 mm UX = 1800 - 3000 mm X min = 30 mm
2L / 1S / 1A 	

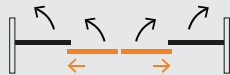
4L / 2S / 2A 	FW = 1800 - 6500 mm FH = 1900 - 3000 mm COW = 800 - 2200 mm COH = 1900 - 3000 mm UX = 1800 - 6500 mm X min = 30 mm
4L / 2S / 4A 	

* S = sliding leaf, L = leaf, A= antipanic leaf, FW = frame width, FH = frame height,
COW = clear opening width, COH = clear opening height, UW = Unit width, X = distance



300 A | thermo 1L/1S/1A on the wall

Vertical section view

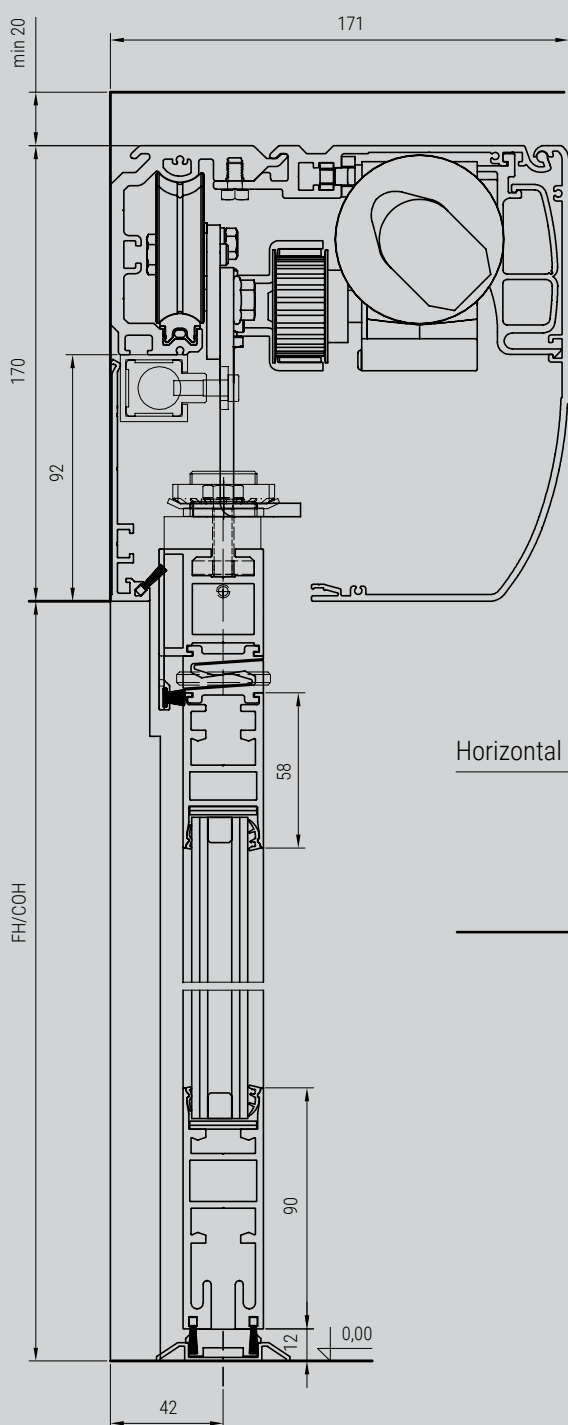

Front view

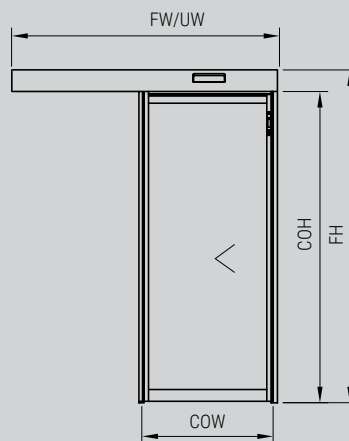

Horizontal section view

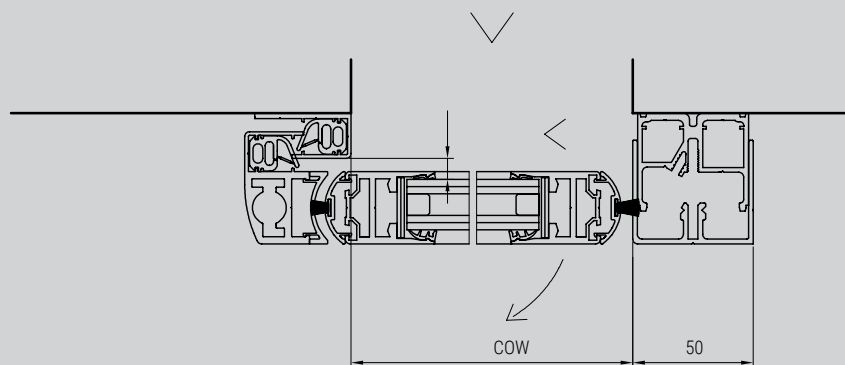

Inspiration on the corner

300 P | prismatic sliding door

A door entrance on the corner of a building could be an architectural challenge. By using a prismatic door you can create an exceptional lobby, withdrawn from wind and rain.

A double leaf prismatic door on the corner maintains the geometric glass screen symmetry and makes the entrance seem invisible.

The prestigious entrance becomes a part of the modern hotel building. It creates a functional and efficient entrance, without any restriction to moving people.

A unique solution that challenges architectural creativity.









Business building entrance



Rimske Terme | architecture: Biro Arhiveda, Rafko Napast

Technical data | 300 P

USE	interior/exterior
DRIVE	height: 100 mm
DIMENSIONS	2 leaves: clear opening width 800 - 3000 mm clear opening height 1900 - 3000 mm
WEIGHT	PR4: max. 120 kg per sliding leaf PR5: max. 160 kg per sliding leaf
OPENING - CLOSING SPEED	0.3 - 0.7 m/s (adjustable)
OPENING TIME	0 - 60 s (adjustable)
POWER CONSUMPTION	max 300W/230V < 0.5W power consumption in sleeping mode
LEAF	float, thermo, panel
INSTALLATION	wall installation, between the wall, under the ceiling, with top screen, in the wall
PROFILE COLOR	anodized aluminium: natural RAL color
GLASS COLOR	different color options
DOOR OPENING	sensor, switches, smartphone, access control
FUNCTIONALITY	a variety of adjustable functions and parameters switching between different door regimes: OPEN, LOCK, STOP, AUTO-SUMMER, AUTO-WINTER, ONE WAY-SUMMER, ONE WAY-WINTER warning diagnosis by COM20
ENERGY SAVING	✓
EMERGENCY EXIT	✓
BATTERY	included
ELECTRIC LOCK	included
STANDARDS	EN 16005, EN 16361

<p>2L / 2S</p> 	<p>FW = 1600 - 6500 mm FH = 1900 - 3000 mm COW = 800 - 3000 mm COH = 1900 - 3000 mm UW = 1670 - 6500 mm Xmin = 10 mm</p>
<p>4L / 2S</p> 	<p>FW = 1600 - 6500 mm FH = 1900 - 3000 mm COW = 800 - 3000 mm COH = 1900 - 3000 mm UW = 1670 - 6500 mm Xmin = 30 mm</p>

* S = sliding leaf, L = leaf, FW = frame width, FH = frame height, COW = clear opening width, COH = clear opening height, UW = Unit width, X = distance



300 P | float 2L/2S on the wall

Vertical section view

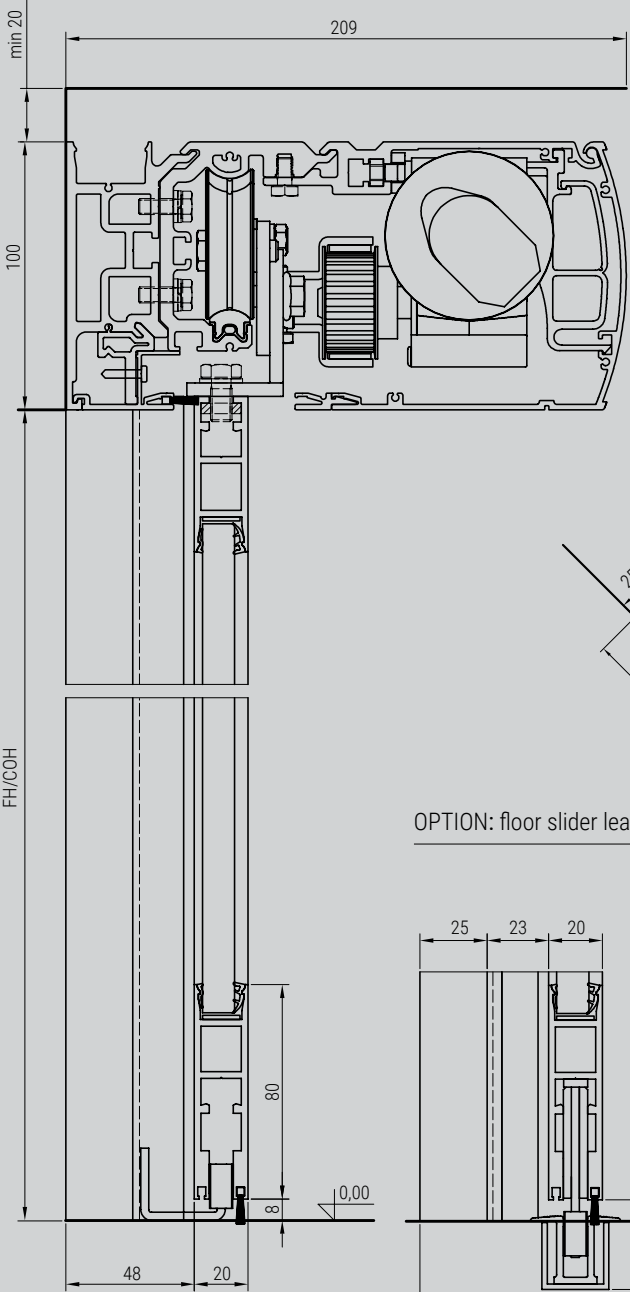

Front view

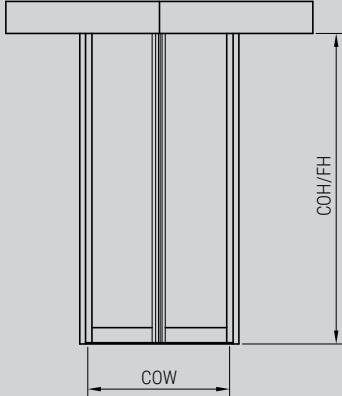

Horizontal section view

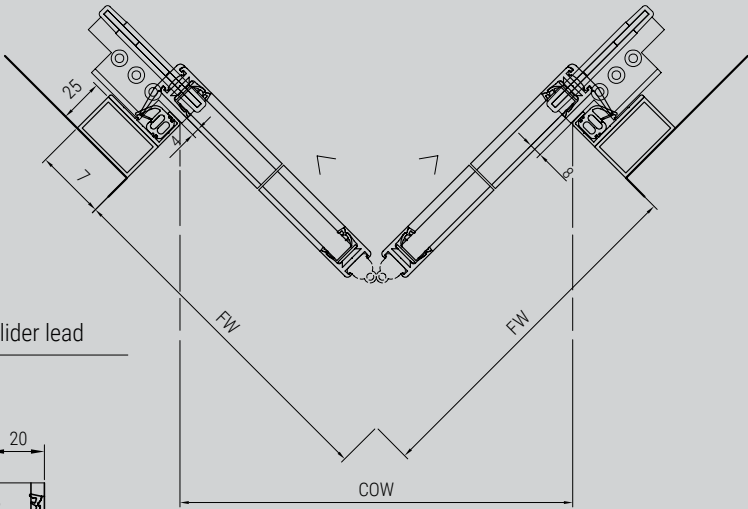

OPTION: floor slider lead

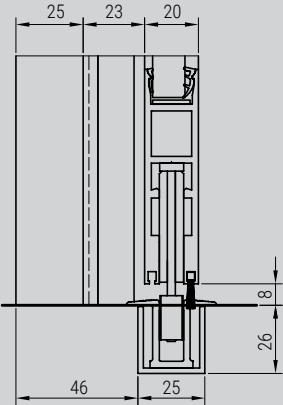



Great first impression



300 C | curved sliding door

Curved sliding door 300 C is an excellent choice to make the best first impression on your guests, clients or visitors.

Convenient for different main entrances, such as hotel resorts, office buildings, restaurants and other luxury buildings where visual impact is a part of their business success.



Custom designed solutions from 120°, 180° or 360°, produced according to the customer's needs. Waterproof roof, thermo profiles, ceiling with integrated lights, sensors or air curtain are possible.

Moreover, the 300 C's special feature is the integrated canopy with built-in LED lights and sensor that complete the exceptional design and luxury.





Entrance to a business center





Technical data | 300 C

USE	exterior
DRIVE	height: adaptable (min. 260 mm)
RADIUS	min. r = 1000 mm max. r = adaptable
CLEAR OPENING HEIGHT	max. 2500 mm
WEIGHT	max. 125 kg per sliding leaf
OPENING - CLOSING SPEED	0.3 - 0.7 m/s (adjustable)
OPENING TIME	0 - 60 s (adjustable)
POWER CONSUMPTION	max 300W/230V < 0.5W power consumption in sleeping mode
LEAF	thermo
INSTALLATION	wall installation, between the wall, under the ceiling
PROFILE COLOR	anodized aluminium: natural RAL color
GLASS COLOR	different color options
DOOR OPENING	sensor, switches, smartphone, access control
FUNCTIONALITY	a variety of adjustable functions and parameters switching between different door regimes: OPEN, LOCK, STOP, AUTO-SUMMER, AUTO-WINTER, ONE WAY-SUMMER, ONE WAY-WINTER warning diagnosis by COM20
ENERGY SAVING	✓
EMERGENCY EXIT	✓
BATTERY	included
ELECTRIC LOCK	included
STANDARDS	EN 16005, EN 16361

<p>180°</p>	<p>FW = 2000 - 4000 mm FH = 1900 - 2500 mm COW = 2000 - 4000 mm COH = 1900 - 2500 mm Rmin= 1000 mm</p>
<p>360°</p>	<p>FW = 2000 - 4000 mm FH = 2200 - 2950 mm COW = 2000 - 4000 mm COH = 1900 - 2500 mm Rmin= 1000 mm</p>

* FW = frame width, FH = frame height, COW = clear opening width, COH = clear opening height, R = radius

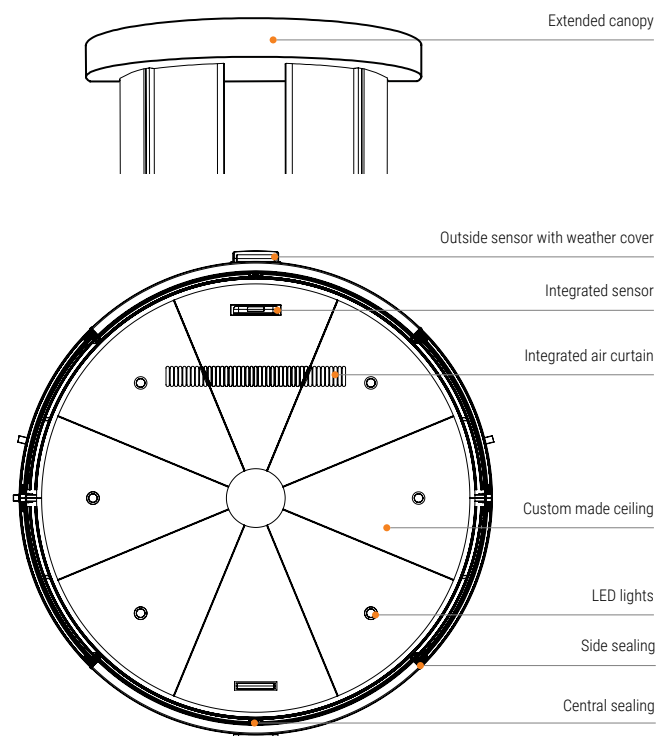

300 C | thermo 4L/2S on the wall

Front view

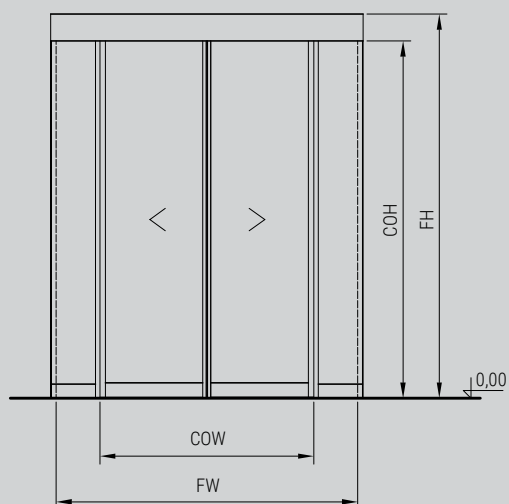

Horizontal section view

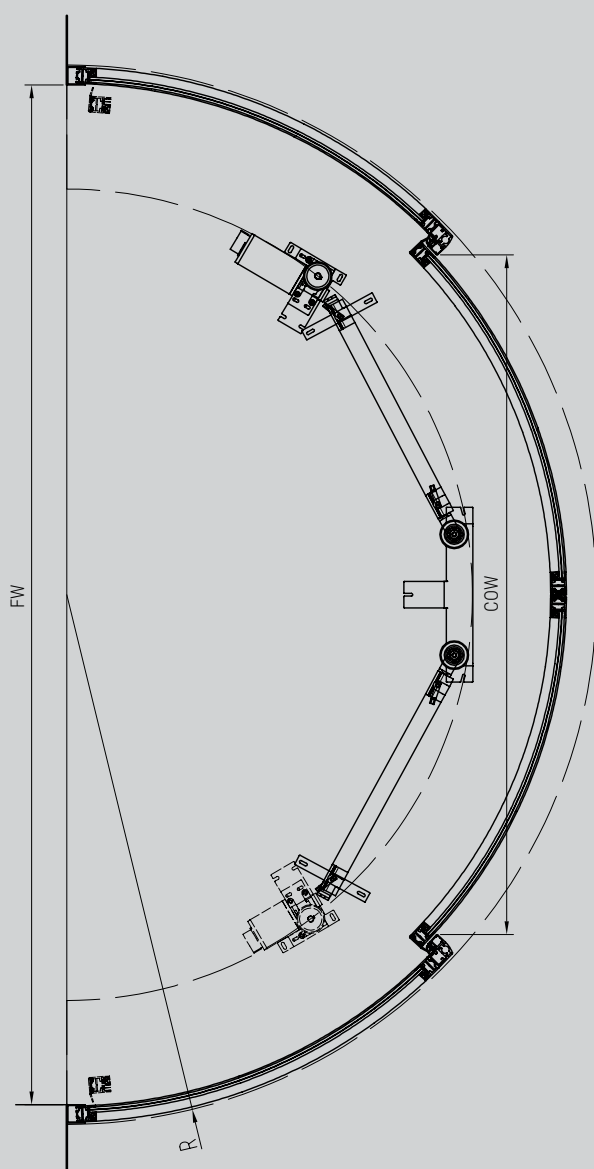

Operator

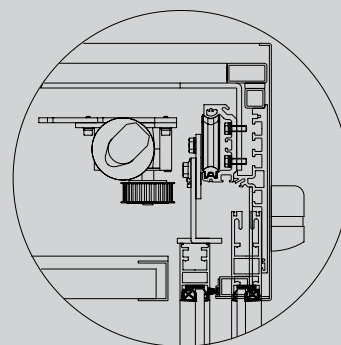

Side sealing

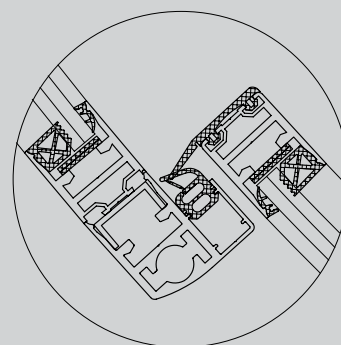

Central sealing

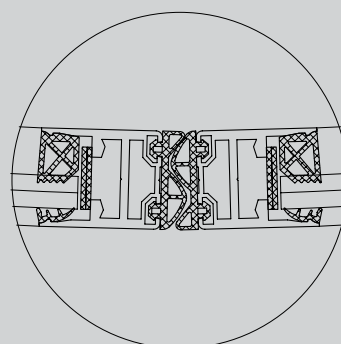

Floor sealing

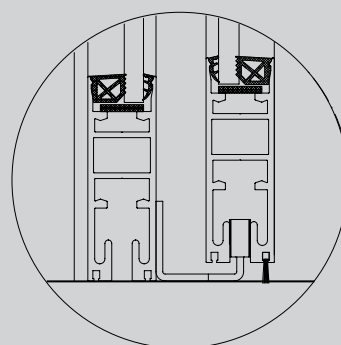

Customize your door

Make it right, make it simple

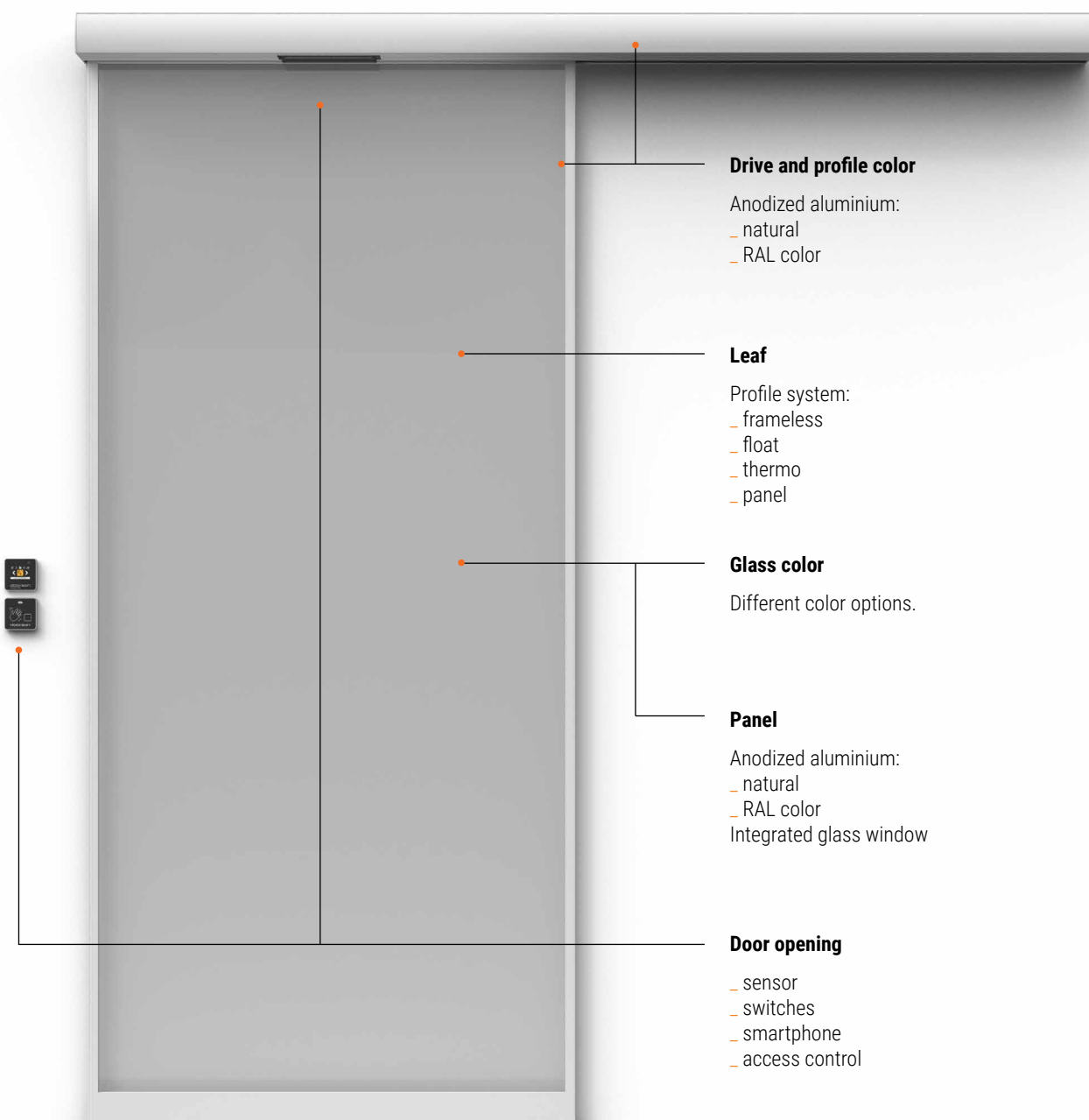

1. Door installation

Creative fitting systems.

Available on
Door calculator

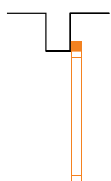

On the wall

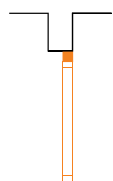

Between the wall

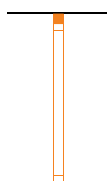

Under the ceiling

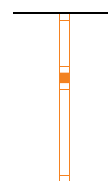

With top screen

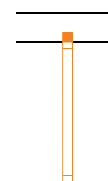

In the wall

2. Leaf

Drive is assembled with door leaves made of wide range frame profile systems.



Frameless
tempered glass 10 mm



Float
PR4 profiles for single safety glass
from 6 - 10 mm



Thermo
PR5 profiles for isolating safety glass
from 19 - 21 mm,
single safety glass 10 mm



Panel
PR4 profiles: panel 10 mm,
PR5 profiles: insulating panel 21 mm

PANEL

The panel can either be natural anodized, in RAL color or with integrated glass window. It is a perfect solution to impact resistance or to provide a high level of hygiene.



3. Door opening

Choose your access. Select the best opening possibilities.

SENSOR



Sensor detection

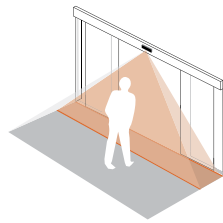

Mounting heights of up to 3 m. Detect people and objects in a range up to 2.5 m.

Sensor installation

Suitable for different types of applications.

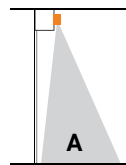

On cover

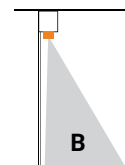

In cover

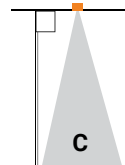

On/In the ceiling

Sensor is the key element to moving the door. The detection area activates the door to open, while the safety area provides pedestrian safety when the door is closing.

DOOR SWITCHES



COM 20 | touchscreen switch



COM 21 | mechanical switch



SMART SWITCH | touchless opening



SMART LOCK | touchless opening and locking



EMERGENCY SWITCH | open/close



CLOUD GATEWAY | access control

SMARTPHONE CONTROL



Control your system remotely 24/7 with the mobile app **Door Cloud**.

Door Cloud

The door mobile app enables you to change door regimes, take a look at the statistics and reset the parameters. Receive notifications, warnings and always be up to date.



Privacy



Access control



Control centre



Notifications



Calendar



Wireless

ACCESS CONTROL



Card reader
Access controller with an integrated card reader.



Card reader with keypad
PIN code access control.



Remote controller
Remote controller for distant door opening and closing.



First opening switch
One time entrance key opener SE-1 or a built-in wall SE-2.



400_ product line

Stylish design & functionalities



Product line 400 is stylish designed interior automatic sliding doors. Slim door lines, colors and decor create a modern, elegant and luxurious product.



An attractive 6 cm slim drive with three different leaf solutions and a wide range of premium materials presents a complete story of perfection. It is the right match for any interior, creating a unique and modern space.



ОБЪЕДИНЕННЫЙ РУССКИЙ СЕРВИС



Design & functionality

Details make all the difference



Product line 400 is defined by a small and powerful 6 cm slim drive that represents the perfect solution to any design or application challenge. The built-in sensor provides a safe and comfortable access for everyone.

Since our automatic sliding doors consume less than 0.5 W of electricity in sleep mode, you cut your costs and contribute to a cleaner environment.

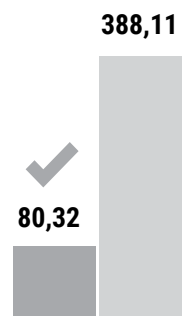

6 cm
drive height

built-in
sensor
for pedestrian safety

< 0.5 W
power consumption

70%
saving energy
and reducing CO²



ACCESS

Provide a comfortable, safe and secure access for everybody.



MOBILE CONTROL

The easiest way to control your door from anywhere and anytime.



DIAGNOSTICS

Warnings and errors description.



DOOR CLOUD

Doors are connected to the cloud. Solve your problem remotely.



CAN

Door controller is CAN connected with sensors, switches and smart devices.



SAFETY OPERATION

Advanced security becomes possible with advanced technology. Your safety is our highest priority.

Business

Your first impression

First impression counts, especially in the business environment. With many application possibilities, such as clinics, business offices or stylish restaurants, product line 400 is designed to impress.

While offering many possibilities, its stylish design expresses the personality and creativity of the project. With wide selection of material combinations, technical performance and dimensions, it is an architectural element in your interior.

smart
design





Inspired solutions

Space with personality

Imagine your living space and add a personal touch with your ideas. Choose interior automatic doors 400 and combine them with your interior design. Your very own personalized door will be stylish, modern and functional.

Whether you are designing a hotel room, restroom, restaurant or your home, the 400 product line will always find their place. Use them and turn your space into something truly beautiful.

personal
touch

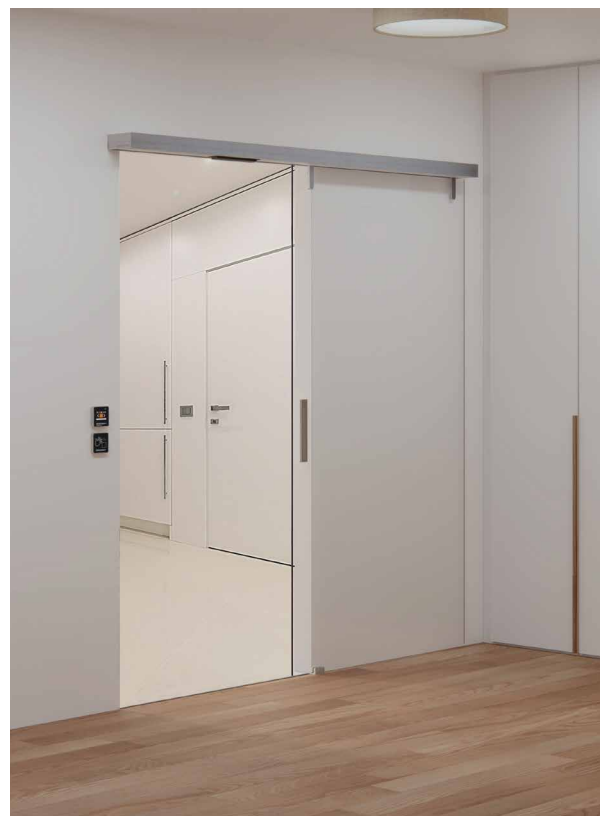





Product range 400_

Upgrade any interior with design creativity



Product line 400 is the perfect solution for any interior. It matches your style, complements your furniture and integrates into your space. Choose between three different leaf options that will integrate into your interior design.

The product declares according to CE certification and meets EN 16005 and EN 16361 standards.



78

400 thales | frameless sliding door
Transparent purity



86

400 fusion | glass sliding door
Beautifully distinct



94

400 timber | wood sliding door
Natural touch





Transparent purity

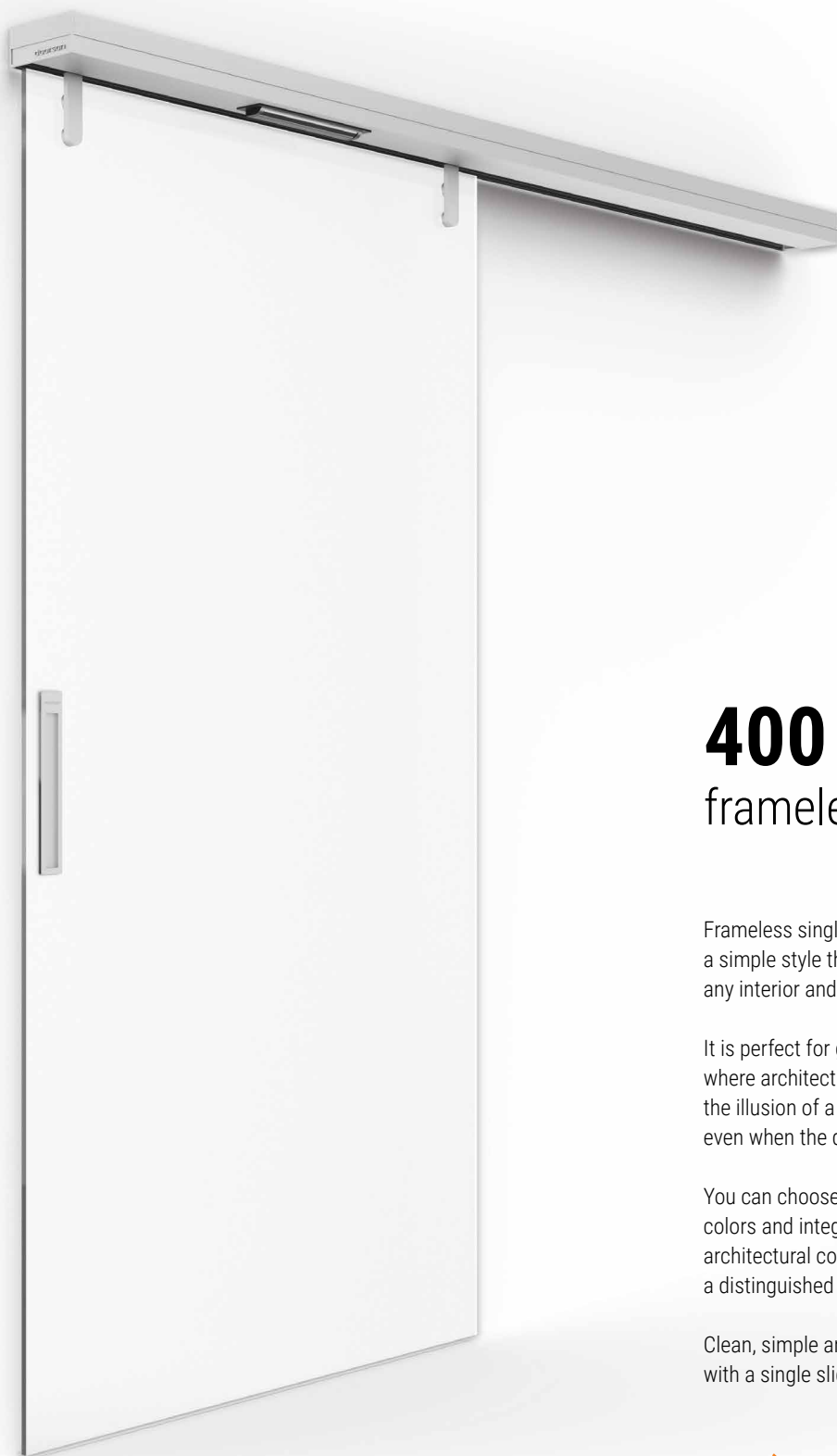

400 thales | frameless sliding door

Frameless single glass door leaf offers a simple style that can integrate into any interior and is practically invisible.

It is perfect for glass wall partition spaces, where architecture transparency creates the illusion of a bright and open space, even when the door is closed.

You can choose between different glass colors and integrate them into every architectural composition, thus creating a distinguished personal view.

Clean, simple and transparent solution with a single sliding door.



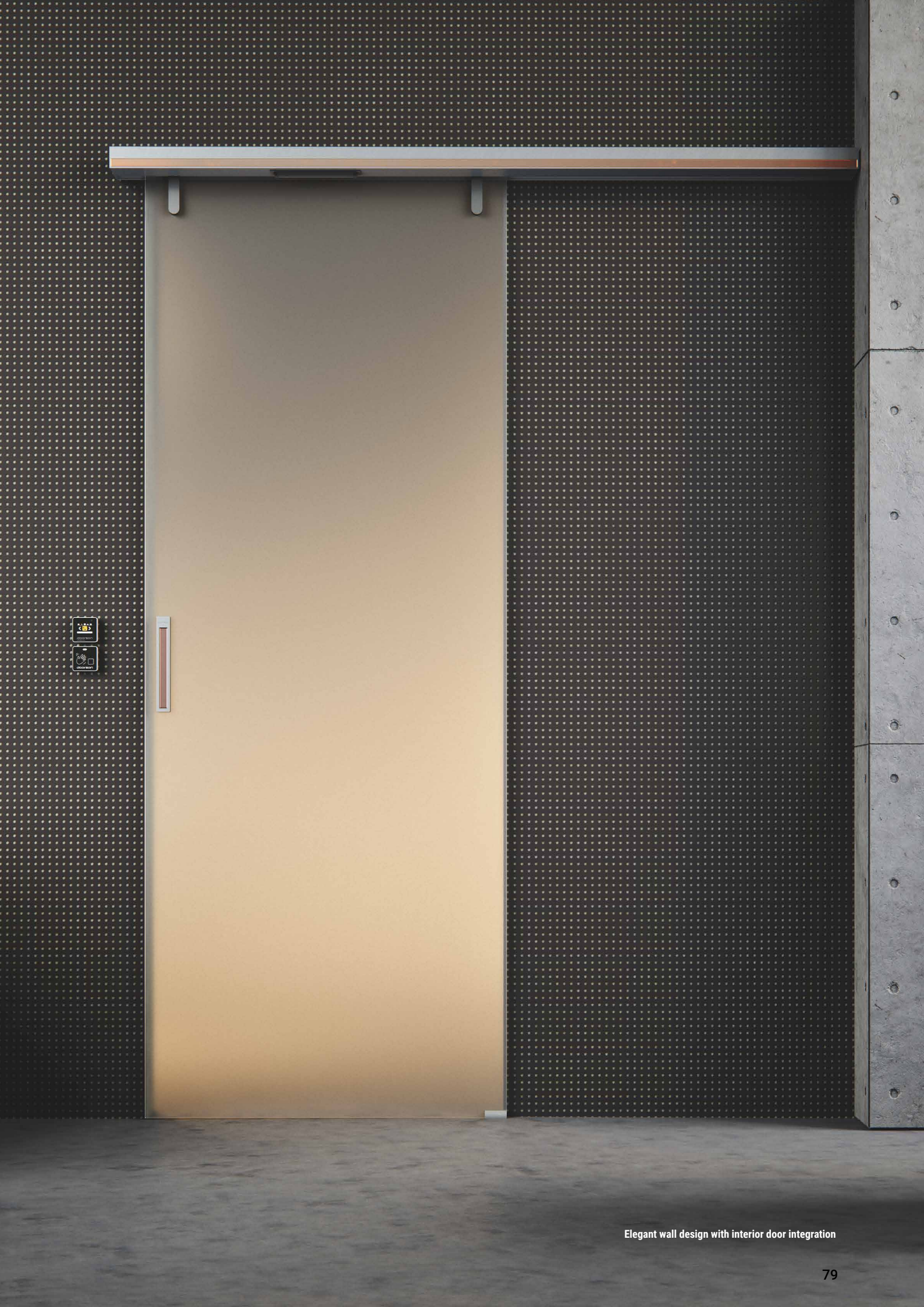









Restaurant



Wardrobe

Technical data | 400 thales

USE	interior
DRIVE	height: 60 mm
DIMENSIONS	1 leaf: frame opening width 700 - 1100 mm frame opening height 1900 - 2500 mm * COW = FW - 65 mm
WEIGHT	max. 65 kg per sliding leaf
OPENING - CLOSING SPEED	0.3 - 0.7 m/s (adjustable)
OPENING TIME	0 - 15 s (adjustable)
POWER CONSUMPTION	max 300W/230V < 0.5W power consumption in sleeping mode
LEAF	frameless 10 mm single ESG tempered safety glass
INSTALLATION	wall installation
PROFILE COLOR	anodized aluminium: Rf shiny, natural, brushed champagne
GLASS COLOR	different color options from doorson collection
DECOR BAND	a variety of options to decorate the handle and drive with wood or color pattern from doorson collection
DOOR OPENING	sensor, push & go, smartphone, switches, access control
FUNCTIONALITY	a variety of adjustable functions and parameters switching between different door regimes: OPEN, LOCK, STOP, AUTO-SUMMER, AUTO-WINTER, ONE WAY-SUMMER, ONE WAY-WINTER warning diagnosis by COM20
ENERGY SAVING	✓
STANDARDS	EN 16005, EN 16361



1L/1S	FW = 700 - 1100 mm FH = 1900 - 2500 mm COW = FW - 65 mm COH = FH UW = 2 * COW + 96 mm + X Xmin = 32 mm
-------	---

* S = sliding leaf, L = leaf, FW = frame width, FH = frame height, COW = clear opening width, COH = clear opening height, UW = Unit width, X = distance



400 thales | 1L/1S on the wall

Vertical section view

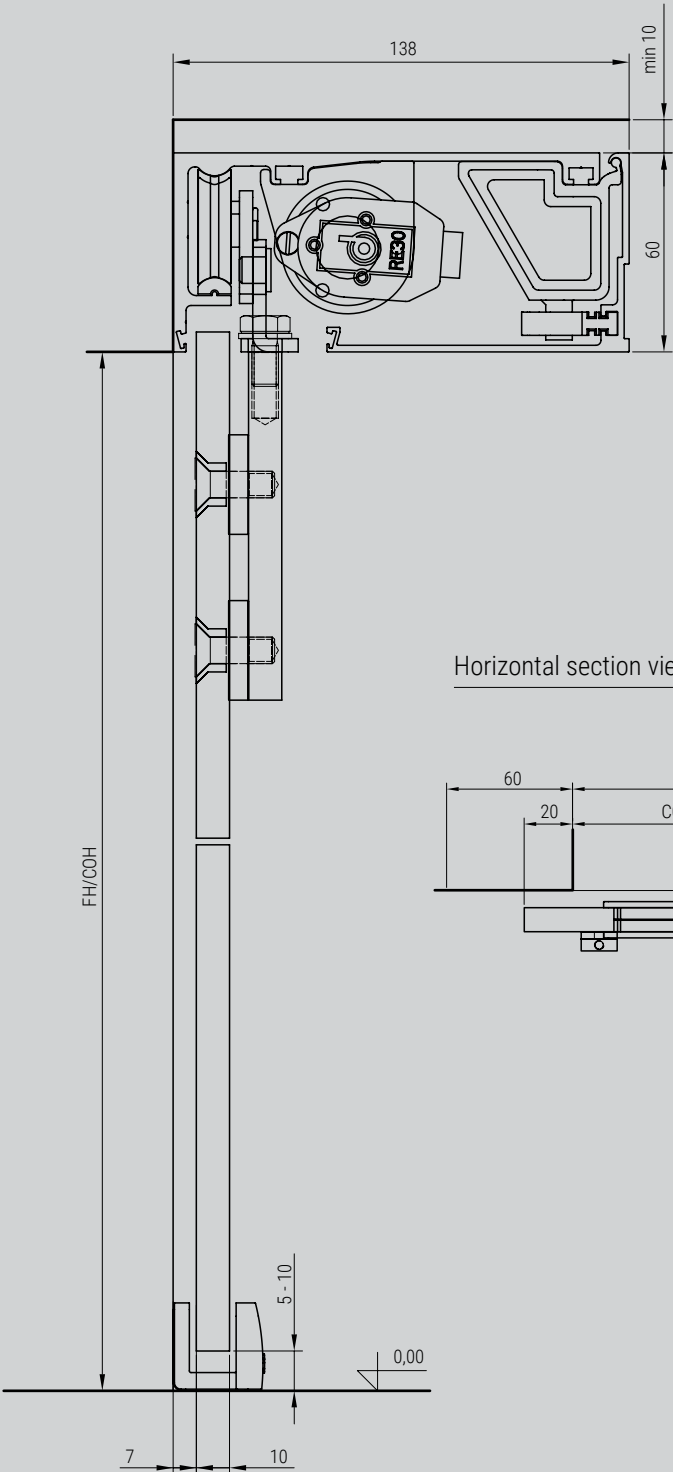

Front view

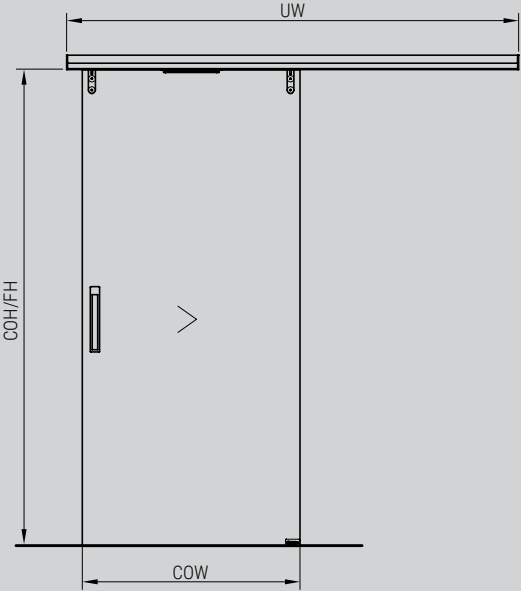

Horizontal section view

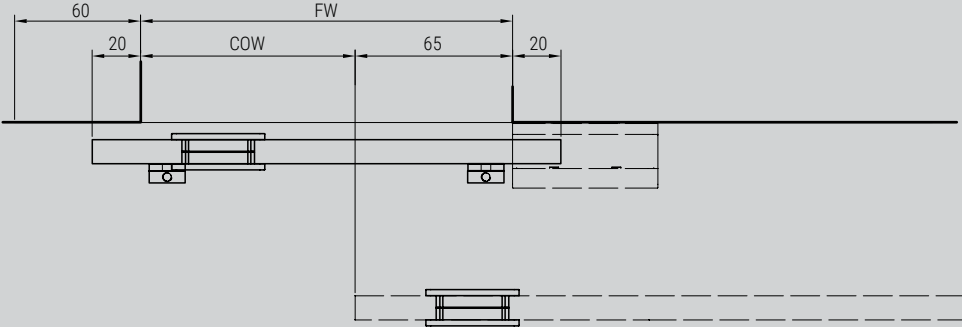



Beautifully distinct



400 fusion | glass sliding door

Fusion is your first choice when you want to express an elegant, modern look. The combination of aluminium frame with double glass gives the door an individual character like no other.

Perfect for offices, hotels, management or any other premium space where you want to combine luxury access with a stylish design.

Use your imagination, create impressive designs that inspire. Fusion is an individual selection for architectural solutions. Slim design, modern glass colors, anodized surface treatment and decoration make the door truly stand out.







Gym changing room







Management Office



Hotel reception

Technical data | 400 fusion

USE	interior
DRIVE	height: 60 mm
DIMENSIONS	1 leaf: frame opening width 700 - 1100 mm frame opening height 1900 - 2500 mm * COW = FW - 65 mm
WEIGHT	max. 65 kg per sliding leaf
OPENING - CLOSING SPEED	0.3 - 0.7 m/s (adjustable)
OPENING TIME	0 - 15 s (adjustable)
POWER CONSUMPTION	max 300W/230V < 0.5W power consumption in sleeping mode
LEAF	aluminum framed double glass leaf, 4 mm ESG tempered safety glass, 30 mm thickness
INSTALLATION	wall installation
PROFILE COLOR	anodized aluminium: Rf shiny, natural, brushed champagne
GLASS COLOR	different color options from doorson collection
DECOR BAND	a variety of options to decorate the handle and drive with wood or color pattern from doorson collection
DOOR OPENING	sensor, push & go, smartphone, switches, access control
FUNCTIONALITY	a variety of adjustable functions and parameters switching between different door regimes: OPEN, LOCK, STOP, AUTO-SUMMER, AUTO-WINTER, ONE WAY-SUMMER, ONE WAY-WINTER warning diagnosis by COM20
ENERGY SAVING	✓
STANDARDS	EN 16005, EN 16361



1L/1S



FW = 700 - 1100 mm
FH = 1900 - 2500 mm
COW = FW - 65 mm
COH = FH
UW = 2 * COW + 96 mm + X
Xmin = 32 mm

* S = sliding leaf, L = leaf, FW = frame width, FH = frame height, COW = clear opening width, COH = clear opening height, UW = Unit width, X = distance



400 fusion | 1L/1S on the wall

Vertical section view

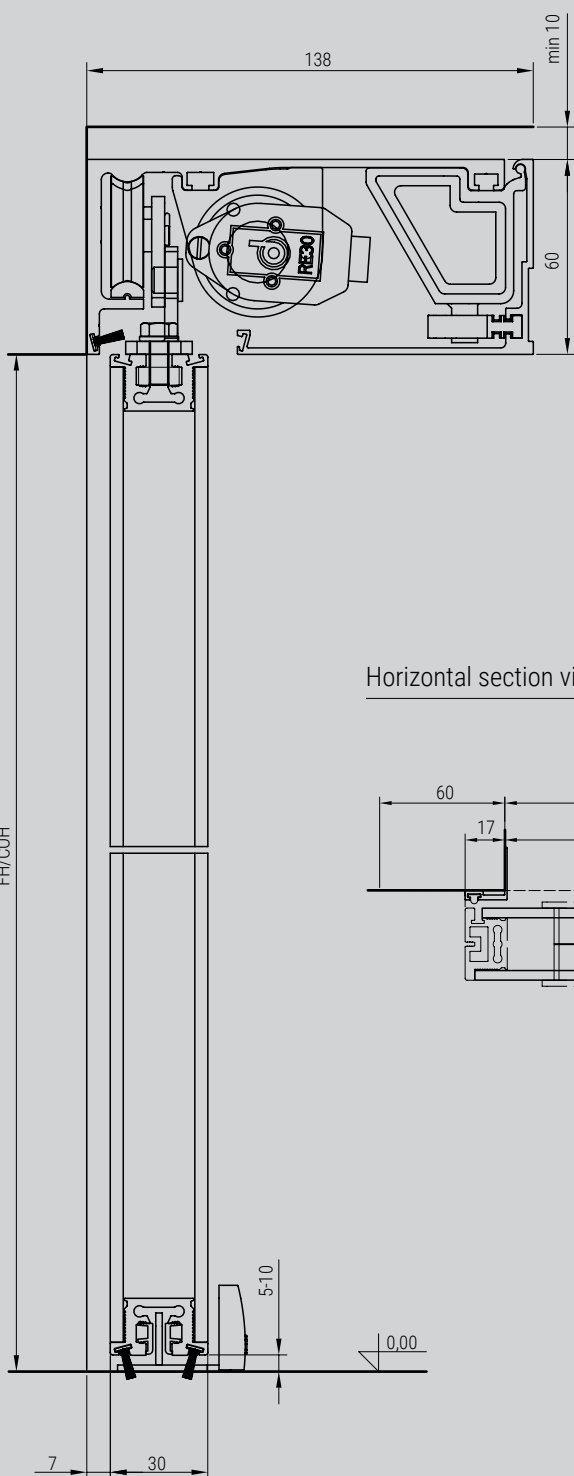

Front view

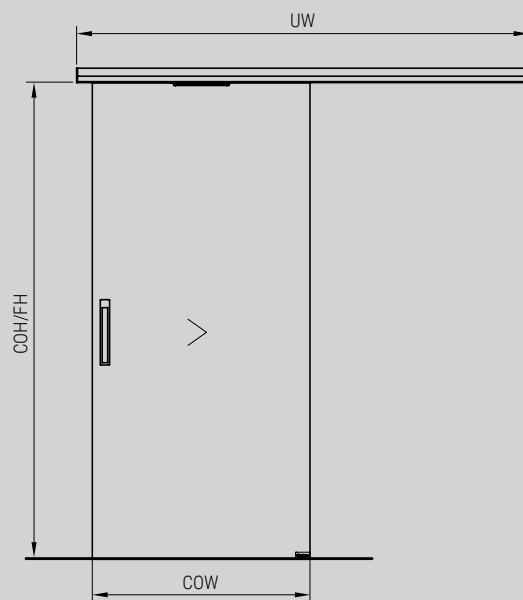

Horizontal section view

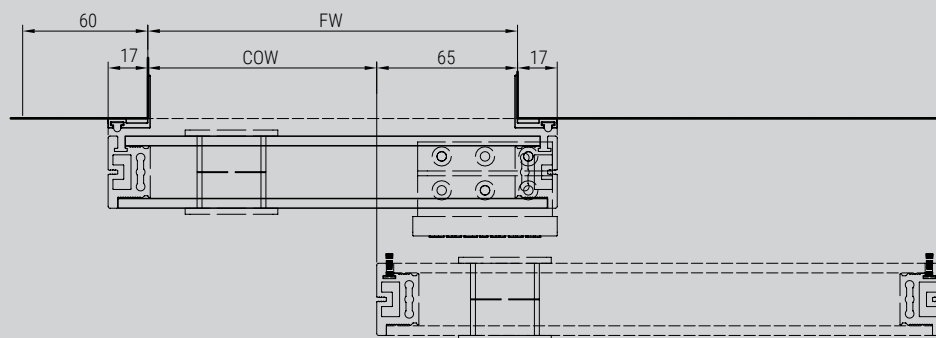



Natural touch

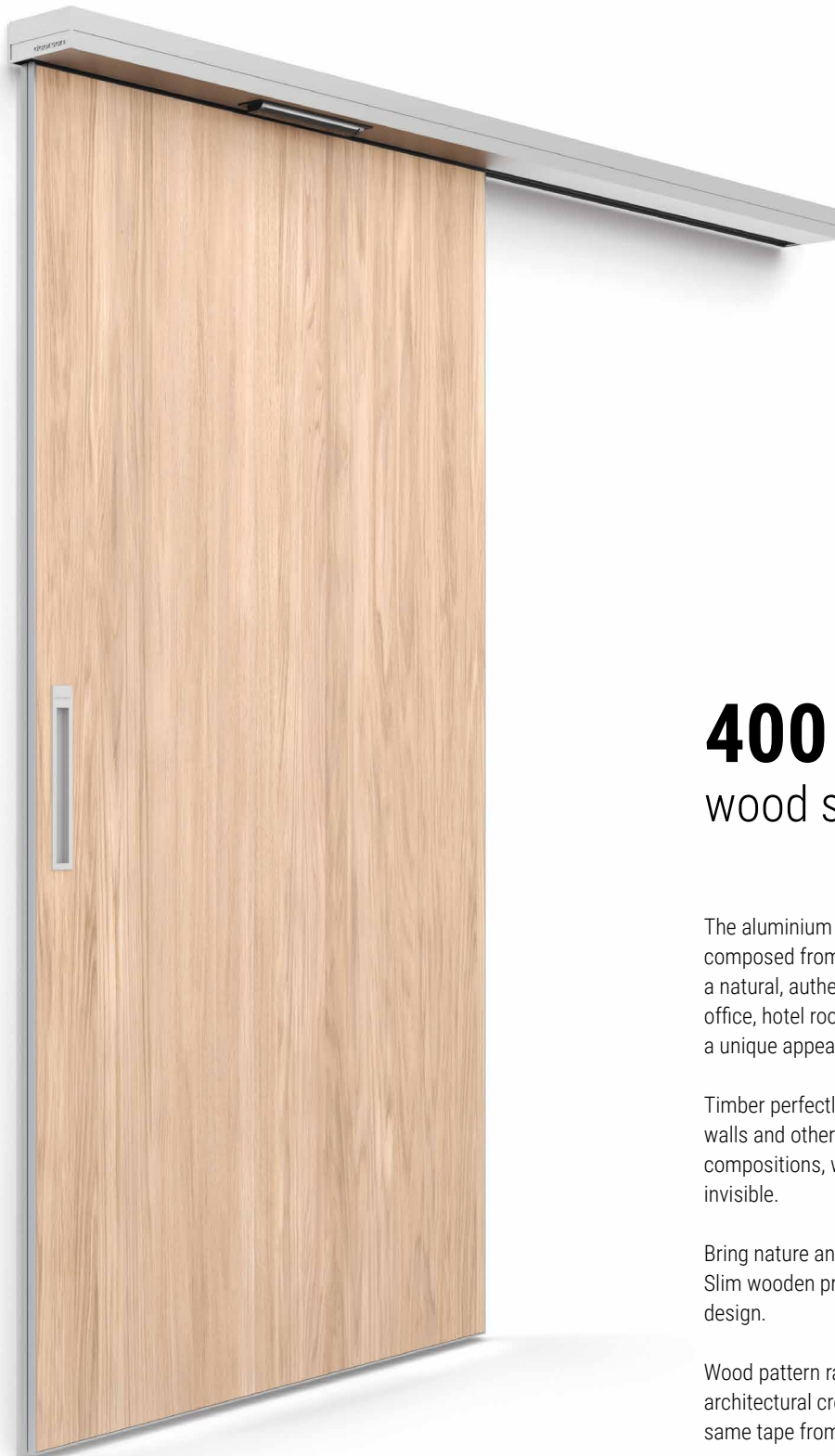

400 timber | wood sliding door

The aluminium framed wooden door, composed from a panel leaf creates a natural, authentic view that gives your office, hotel room, lobby or your home a unique appearance.

Timber perfectly integrates into wooden walls and other interesting architectural compositions, which makes the drive invisible.

Bring nature and warmth into a space. Slim wooden profiles express an esthetic design.

Wood pattern range completes the architectural creation. You can use the same tape from your band ages furniture.











Hotel reception, walnut wood wall



Technical data | 400 timber

USE	interior
DRIVE	height: 60 mm
DIMENSIONS	1 leaf: frame opening width 700 - 1100 mm frame opening height 1900 - 2500 mm * COW = FW - 65 mm
WEIGHT	max. 65 kg per sliding leaf
OPENING - CLOSING SPEED	0.3 - 0.7 m/s (adjustable)
OPENING TIME	0 - 15 s (adjustable)
POWER CONSUMPTION	max 300W/230V < 0.5W power consumption in sleeping mode
LEAF	aluminum framed wooden panel leaf, 30 mm thickness
INSTALLATION	wall installation
PROFILE COLOR	anodized aluminium: Rf shiny, natural, brushed champagne
WOOD PATTERN	different wood pattern options from doorson collection
DECOR BAND	a variety of options to decorate the handle and drive with wood or color pattern from doorson collection
DOOR OPENING	sensor, push & go, smartphone, switches, access control
FUNCTIONALITY	a variety of adjustable functions and parameters switching between different door regimes: OPEN, LOCK, STOP, AUTO-SUMMER, AUTO-WINTER, ONE WAY-SUMMER, ONE WAY-WINTER warning diagnosis by COM20
ENERGY SAVING	✓
STANDARDS	EN 16005, EN 16361

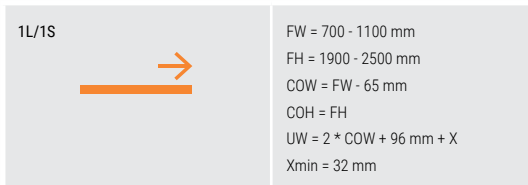

* S = sliding leaf, L = leaf, FW = frame width, FH = frame height, COW = clear opening width, COH = clear opening height, UW = Unit width, X = distance



400 timber | 1L/1S on the wall

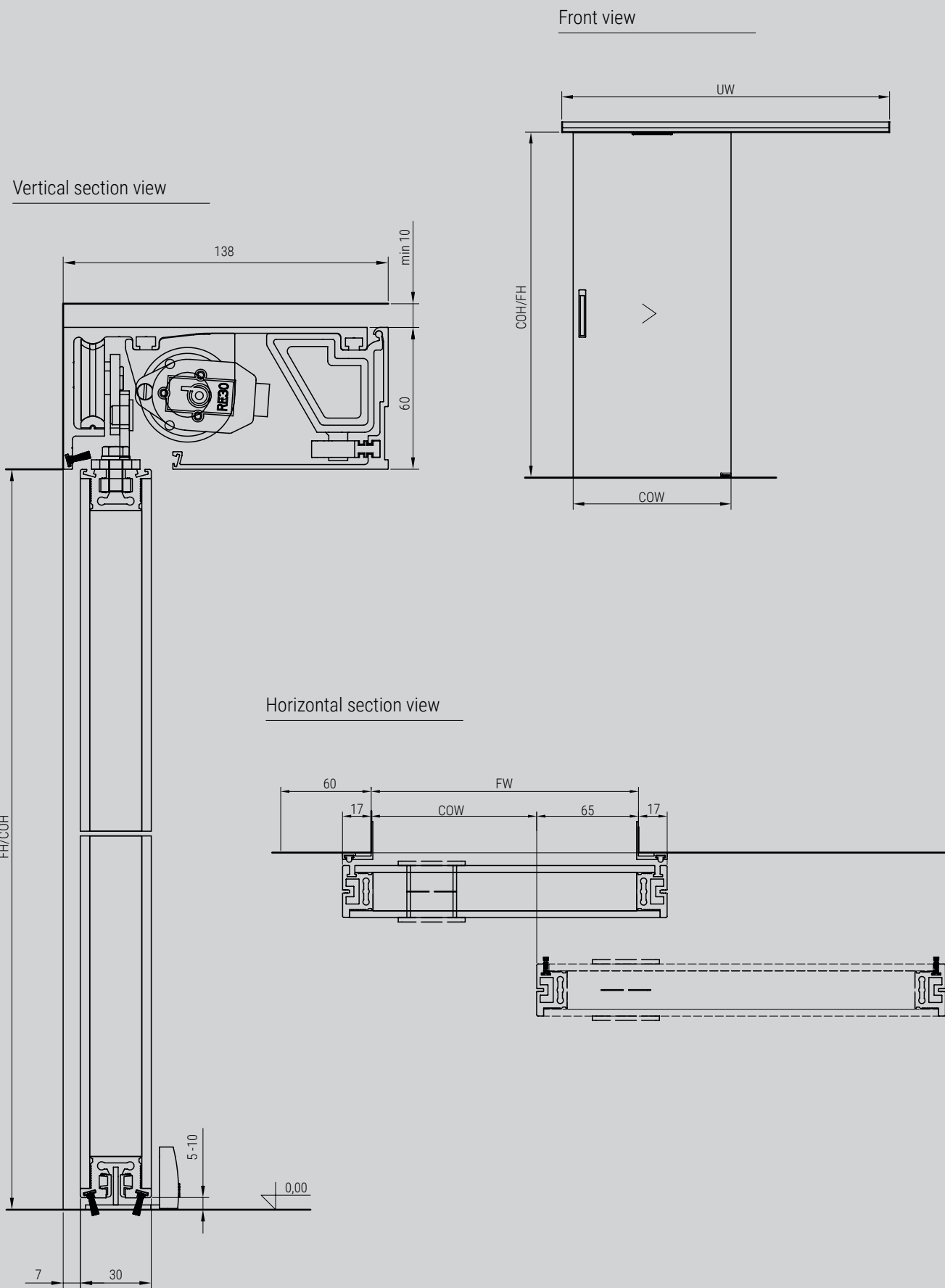

Customize your door

Make it right, make it simple

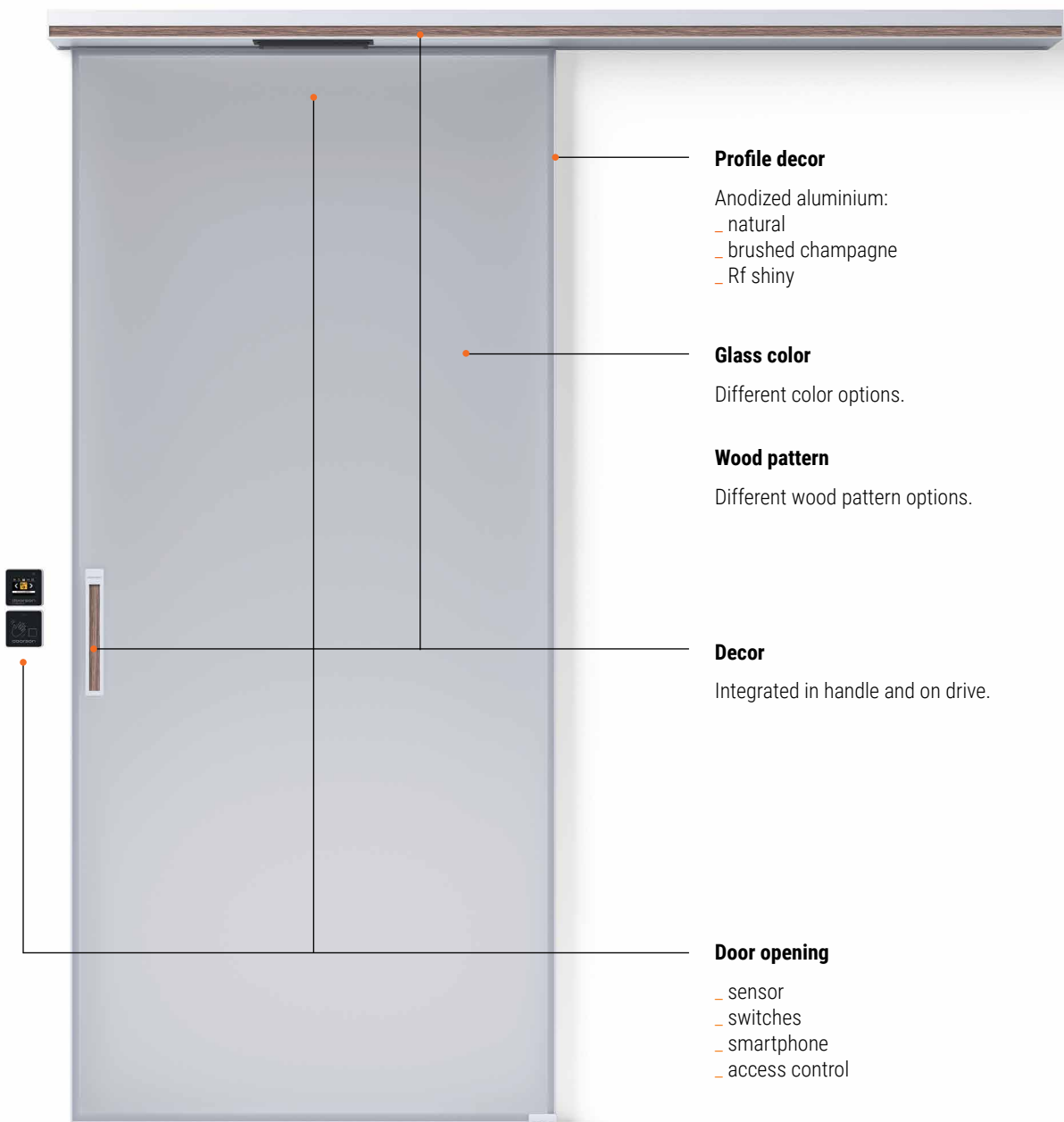

Available on
Door calculator

1. Door installation

Creative fitting systems.

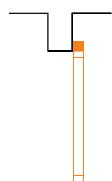

On the wall

2. Leaf

Drive is assembled with door leaves made of wide range frame profile systems.



Thales
frameless 10 mm single ESG
tempered safety glass



Fusion
aluminum framed double glass leaf,
4 mm ESG tempered safety glass,
30 mm thickness



Timber
aluminum framed wooden panel leaf,
30 mm thickness

3. Profile color

Choose the profile color that suits your style.



Anodized Rf shiny



Natural anodized



**Champagne brushed
anodized**

4/a. Glass color

Choose the glass color that best fits your project.

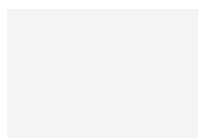

Transparent

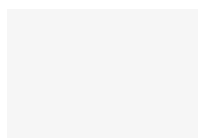

White
RX 1

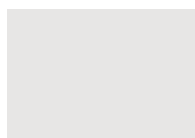

Mat silver
RX 17



Green
RX 22



Blue
RX 24

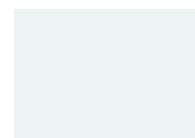

Satin

STICKERS

Create a powerful design without limits to your stickers pattern.

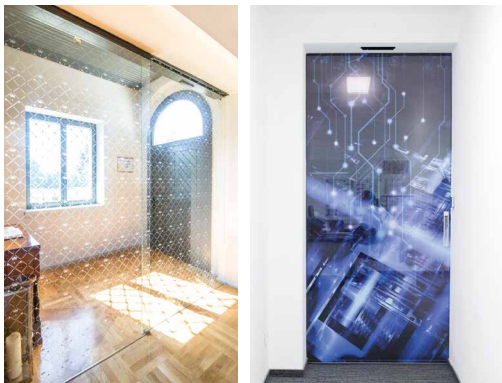

4/b. Wood pattern

Get inspired by our wood pattern leaf selection.



Fineline creme
H1424 ST22



Natural Maple
H3840 ST9



Vicenza Oak
H3157 ST12

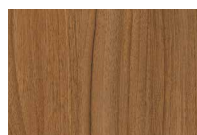

Natural Walnut
H3734 ST9



Shorewood
H3090 ST22

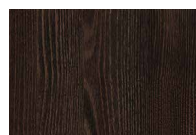

Black-Brown Oak
H1199 ST12

5. Decor

Choose a decor pattern to express your style. Details make the design.

Decor is a powerful design detail. Tape collection of wood, metal, stone, artificial materials, pure color matte or shiny, allows you to decorate the drive or handle. You can combine it with your furniture.



Decor in handle



Decor in drive

*For latest products, please refer to our web page. It is our right to modify materials.

6. Door opening

Choose your access. Select the best opening possibilities.

PUSH & GO



A simple way to open the door is by pushing the door. The door opens and closes after some time delay. The time is adjustable.

SENSOR

Sensor detection

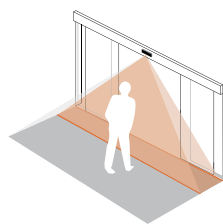

Mounting heights of up to 3 m. Detect people and objects in a range up to 2.5 m.

Sensor installation

Suitable for different types of applications.

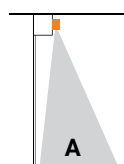

On cover

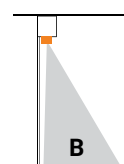

In cover

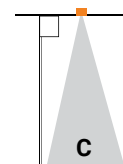

On/In the ceiling

Sensor is the key element to moving the door. The detection area activates the door to open, while the safety area provides pedestrian safety when the door is closing.

DOOR SWITCHES



COM 20 | touchscreen switch



COM 21 | mechanical switch



SMART SWITCH | touchless opening



SMART LOCK | touchless opening and locking



EMERGENCY SWITCH | open/close



CLOUD GATEWAY | access control

SMARTPHONE CONTROL



Control your system remotely 24/7 with mobile app **Door Cloud**.

Door Cloud

The door mobile app enables you to change door regimes, take a look at the statistics and reset the parameters. Receive notifications, warnings and always be up to date.



Privacy



Access control



Control centre



Notifications



Calendar



Wireless

ACCESS CONTROL



Card reader
Access controller with an integrated card reader.



Card reader with keypad
PIN code access control.



Remote controller
Remote controller for distant door opening and closing



First opening switch
One time entrance key opener SE-1 or a built-in wall SE-2.



500_ product line

On the safe side of fire

Fire automatic sliding doors combine the functions of standard sliding opening/closing with fire protection and a safe escape route without compromise.

Fire resistance EI30 and EI60 are used to separate fire sectors and prevent fire spread in the building.

In normal circumstances product line 500 functions as a standard automatic sliding door, providing easy going in-out. In case of an emergency or fire alarm, the sliding door 500 F reliably closes, which creates a barrier that prevents the spread of fire. While 500 EF and 500 EFS additionally transform from a sliding operation to a swing operation and provide a safe evacuation and rescue.





Design & functionality

Safety makes all the difference



The 17 cm drive presents a line shape that integrates into any architecture. Be impressed by reliability, security, robustness and advanced functionality.

The system is equipped with a built-in sensor that provides automatic opening and safety closing. To increase the safety opening, side safety sensors are integrated.

Moreover, additional functionalities are enabled by our very own door switches family.

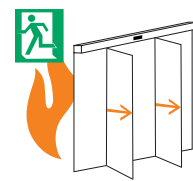

17 cm
drive height

built-in
sensor
for pedestrian safety

fire exit
for safe rescue

EI30 | EI60
fire protection



Provide a comfortable, safe and secure access for everybody.



The easiest way to control your door from anywhere and anytime.



Warnings and errors description.



Doors are connected to the cloud. Solve your problem remotely.

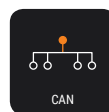

Door controller is CAN connected with sensors, switches and smart devices.



Advanced security becomes possible with advanced technology. Your safety is our highest priority.



Safe escape route in case of an emergency or fire alarm.

Business

Safety access control

An office building is a spread of working places, meeting rooms, halls, corridors, stairs and elevators. An architectural composition that integrates into the planned space organization and is compliant with the security measures.

Fire safety plays an important role in building construction. By using automatic fire sliding doors we bring more comfort, access control and safety in our building.



up to
60 min
fire resistance

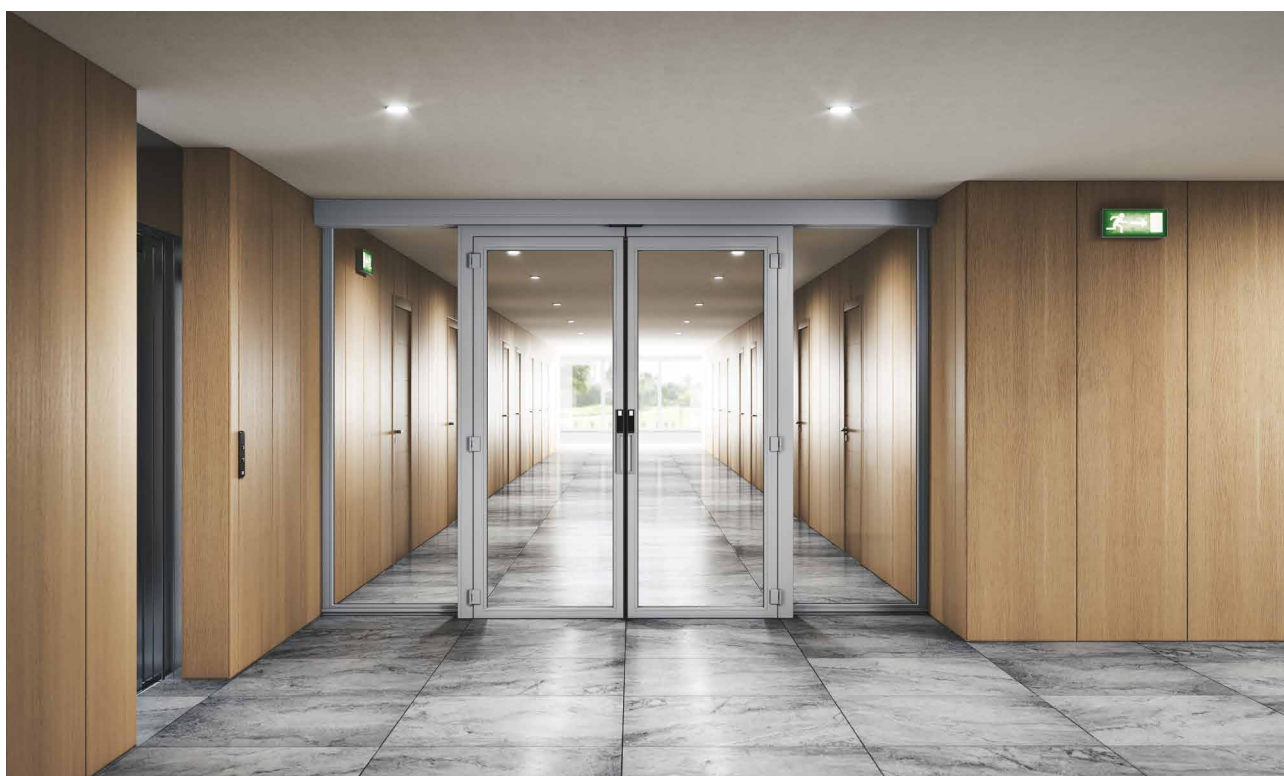

Public places

Smooth people flow



Public places are the heart of our community.

Administrations, schools, faculties, hotels, and shopping areas are our social, education and meeting area. Automatic fire sliding door provides a smooth transition of people, without restrictions for anybody. At the same time they provide the comfort of a daily sliding opening/closing.

emergency exit
for safe evacuation

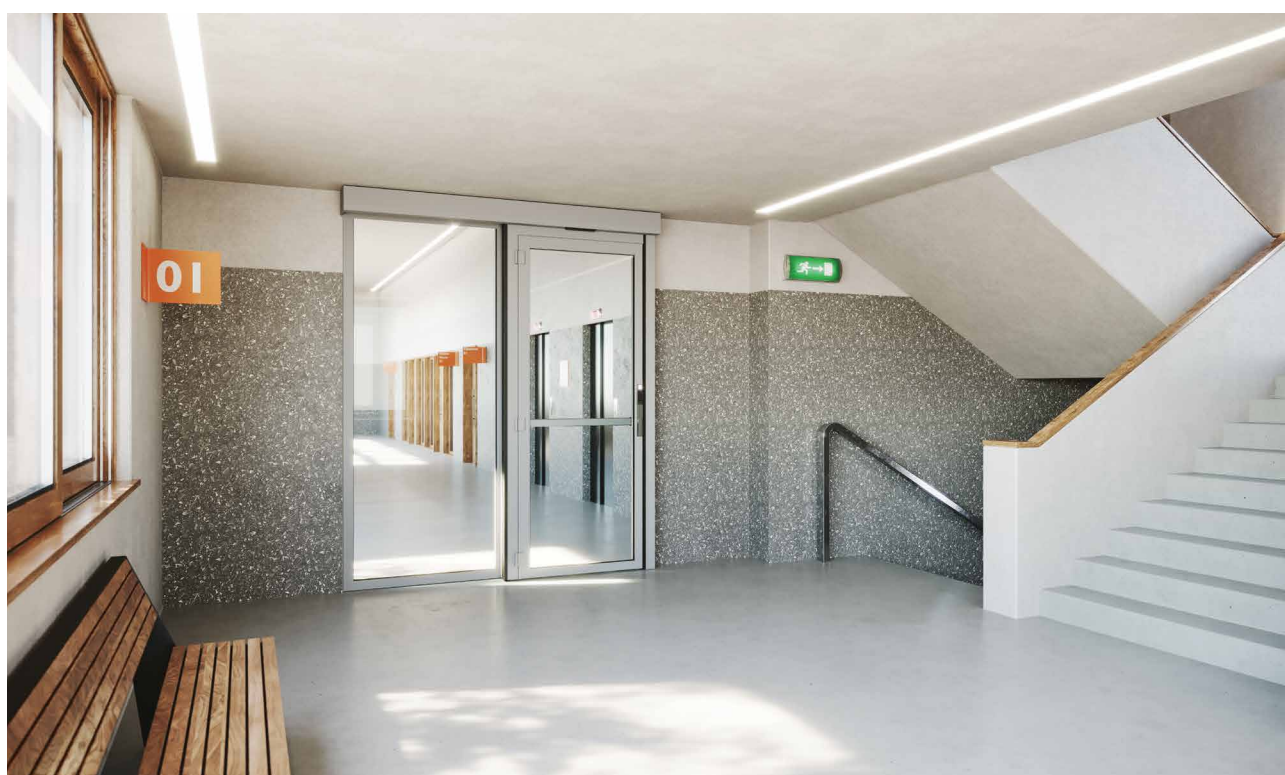

Healthcare

Providing high level of hygiene standards

Doorson _FIRE is a perfect solution for the healthcare sector. Automatic sliding doors increase the level of hygiene and reduce the risk of infections. With a touchless opening everyone can move quickly and safely.

Simple and carefree access.

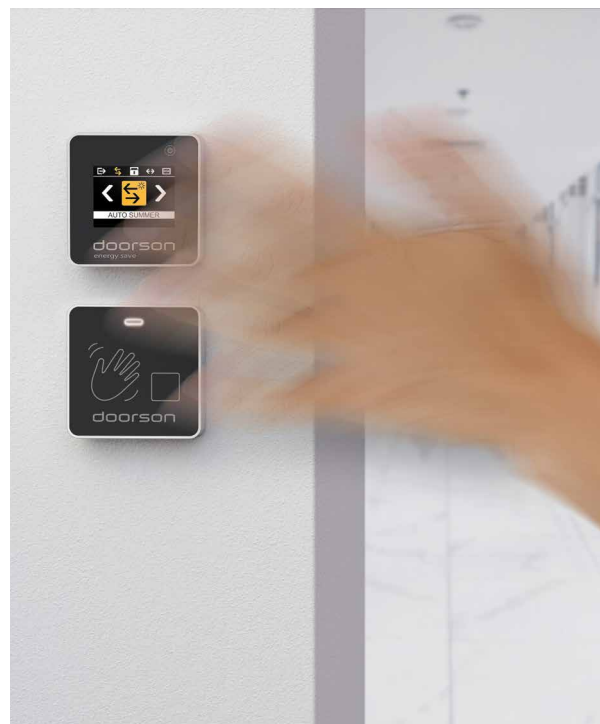

100%
hands-free access







Product range 500_

Fire and exit safety

Fire protection is the highest level between all automatic doors. Security against fire demands more safety, more functionalities, more certifying. You can also use product line 500 on emergency exits and escape routes.

Product line 500 contains EI30, EI60 fire testing and certifying according to European directives and standards EN16005, EN16361, EN1154, EN179, EN1125. Our fire door production is certified.



500 F | fire sliding door
Safety barrier



500 EF | escape fire sliding door
Safety rescue



500 EFS | escape fire sliding door
Easy safety rescue



Safety barrier

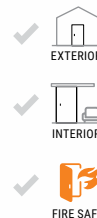

500 F | fire sliding door

Fire sliding door 500 F functions as a standard automatic sliding door and provides a comfortable everyday transition through the door with a fire resistant ability that divides the two fire sectors on NON ESCAPE routes.

It is constructed for 30 or 60 minutes fire resistant fully expanded, from both sides of the door.

In case of an emergency, fire alarm or power failure, the mechanical spring system closes the door and keeps it closed. Escape is not possible.

The closed door resists the fire, which prevents the flames and heat radiation to spread from one sector to another.







Open office space



Technical data | 500 F

USE	interior/exterior for non escape routes
DRIVE	height: 170 mm
DIMENSIONS	1 leaf: clear opening width 800 - 1400 mm clear opening height 1900 - 2500 mm 2 leaves: clear opening width 1600 - 2500 mm clear opening height 1900 - 2500 mm
WEIGHT	max. 300 kg per sliding leaf
FIRE RESISTANCE	EI30, EI60
OPENING - CLOSING SPEED	0.3 - 0.7 m/s (adjustable)
OPENING TIME	0 - 15 s (adjustable)
POWER CONSUMPTION	30/300 VA
LEAF	GLASS: EI30: 15 mm, EI60: 23 mm PANEL: EI30: 26 mm, EI60: 38 mm
INSTALLATION	wall installation
PROFILE COLOR	RAL color
GLASS COLOR	fire safety transparent glass
DOOR OPENING	sensor, smartphone, switches, access control
SECURITY	infrared-microwave activation sensors
FUNCTIONALITY	side safety sensors a variety of adjustable functions and parameters switching between different door regimes: OPEN, LOCK, STOP, AUTO-SUMMER, AUTO-WINTER, ONE WAY-SUMMER, ONE WAY-WINTER warning diagnosis by COM20 connection to fire safety system
EMERGENCY EXIT	X
ELECTRIC LOCK	included
STANDARDS	EN16005, DIN18650, EN1154, EN 13501-2, EN 16034



* S = sliding leaf, L = leaf, FW = frame width, FH = frame height, COW = clear opening width, COH = clear opening height, UW = Unit width, X = distance

Version possibilities

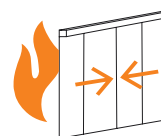
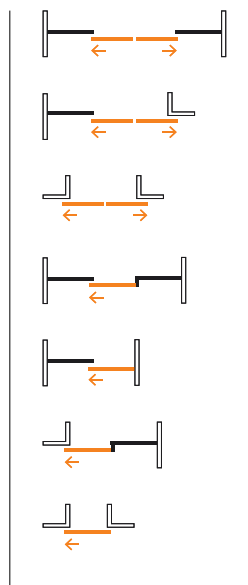

500 F | 2L/2S on the wall

Vertical section view

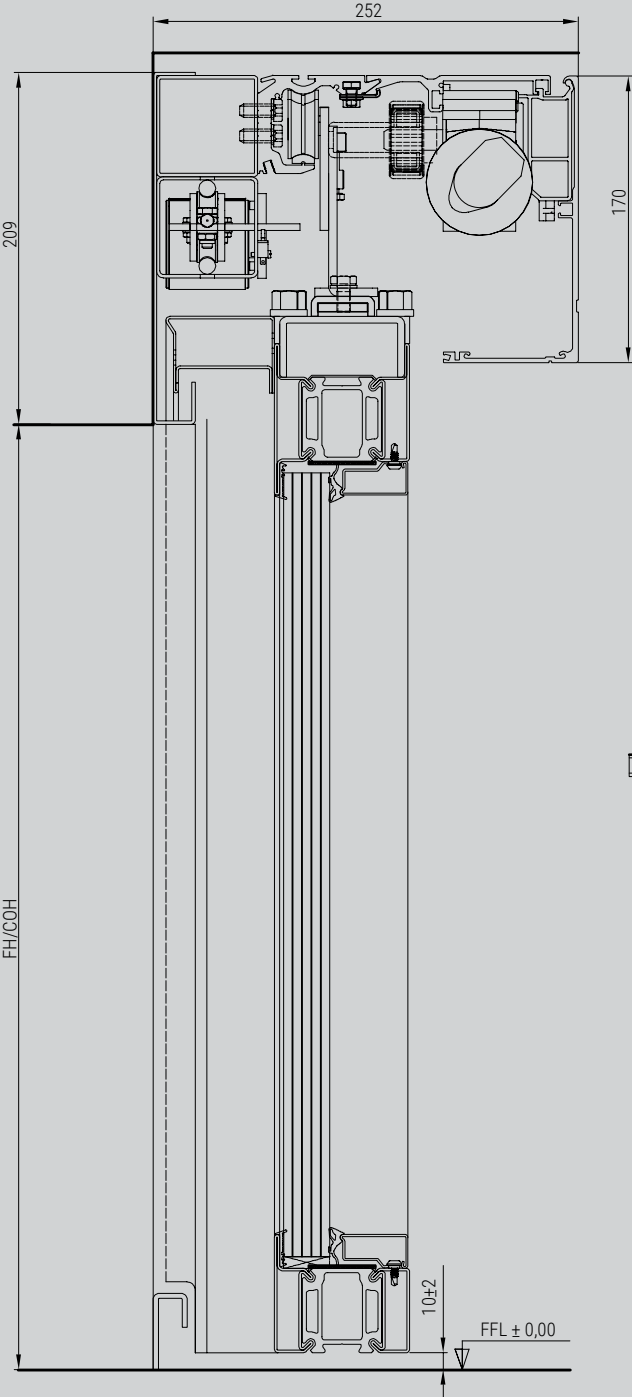

Front view

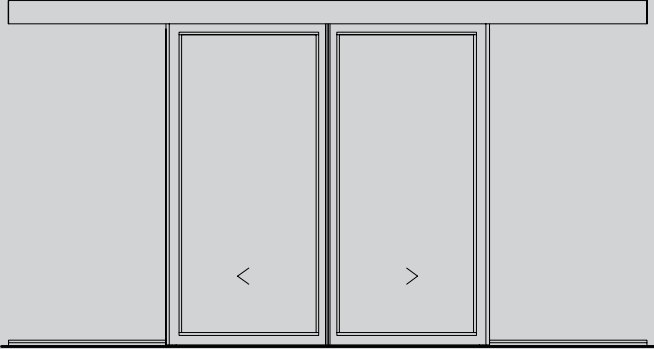

Horizontal section view

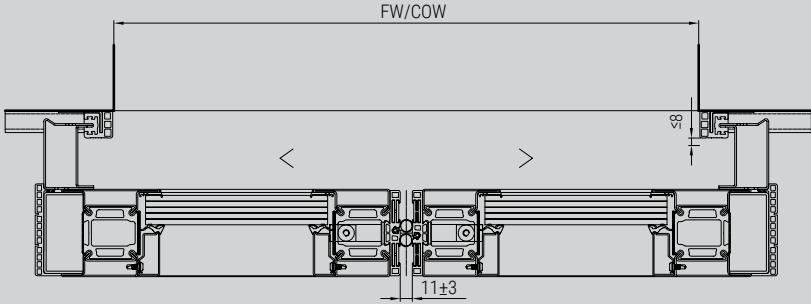

Safety rescue

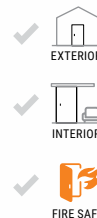

500 EF | escape fire sliding door

Fire sliding door 500 EF functions as a standard automatic sliding door that is convenient for all working spaces. It provides a comfortable everyday transition in-out with fire resistant ability, which divides the two fire sectors on ESCAPE routes. It is constructed for 30 or 60 minutes fire resistant fully expanded, from both sides of the door.

In case of an emergency, fire alarm or power failure, the mechanical spring system closes the door, which then, in a few seconds, transforms into a swing door. Safe evacuation is provided by swing opening, self-closes after that.

A swing opening is provided in the escape direction by pressing the panic bar and pushing the door. On the opposite side of the door, in the rescue direction, a swing opening is enabled by pressing the door handle and by pulling the door.

The swing opening provides a safe rescue of people and goods out of the danger zone. In case of a fire expansion, the door creates a safe barrier that stops the flames and heat from spreading to the safe side.







SERENITY

SNACK



Shopping mall | fire automatic sliding door on escape route, sliding operation for every day entrance, swing opening for emergency use



♂ ♀ ♿ TOILETS ↓



HMS Inc (London)
M : Modern
A : Adventurous
S : Self-confidence/Sophisticated
K : Knowledgeable
Independent Modern Chic
Casual
Dressy Tailored
Occasional

Technical data | 500 EF

USE	interior/exterior for escape routes
DRIVE	height: 170 mm
DIMENSIONS	1 leaf: clear opening width 800 - 1400 mm clear opening height 1900 - 2500 mm 2 leaves: clear opening width 1600 - 2500 mm clear opening height 1900 - 2500 mm
WEIGHT	max. 300 kg per sliding leaf
FIRE RESISTANCE	EI30, EI60
OPENING - CLOSING SPEED	0.3 - 0.7 m/s (adjustable)
OPENING TIME	0 - 15 s (adjustable)
POWER CONSUMPTION	30/300 VA
LEAF	GLASS: EI30: 15 mm, EI60: 23 mm PANEL: EI30: 26 mm, EI60: 38 mm
INSTALLATION	wall installation
PROFILE COLOR	RAL color
GLASS COLOR	fire safety transparent glass
DOOR OPENING	sensor, smartphone, switches, access control
SWING OPENING VARIETY	panic PUSH bar, bi-fold PULL handle
SECURITY	infrared-microwave activation sensors
FUNCTIONALITY	side safety sensors a variety of adjustable functions and parameters switching between different door regimes: OPEN, LOCK, STOP, AUTO-SUMMER, AUTO-WINTER, ONE WAY-SUMMER, ONE WAY-WINTER warning diagnosis by COM20 connection to fire safety system
EMERGENCY EXIT	✓
ELECTRIC LOCK	included
SELFCLOSER	included
STANDARDS	EN14351-1, EN14351-2, EN16034, EN16361, EN16005, DIN18650, EN179, EN1125, EN1154, EN 13501-2, EN 1155, EN 14600

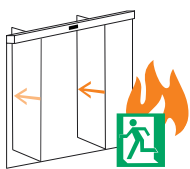

Panic PUSH bar

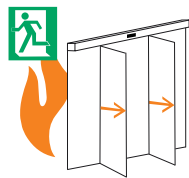

Bi-fold PULL handle



* S = sliding leaf, L = leaf, FW = frame width, FH = frame height, COW = clear opening width, COH = clear opening height, UW = Unit width, X = distance

Version possibilities

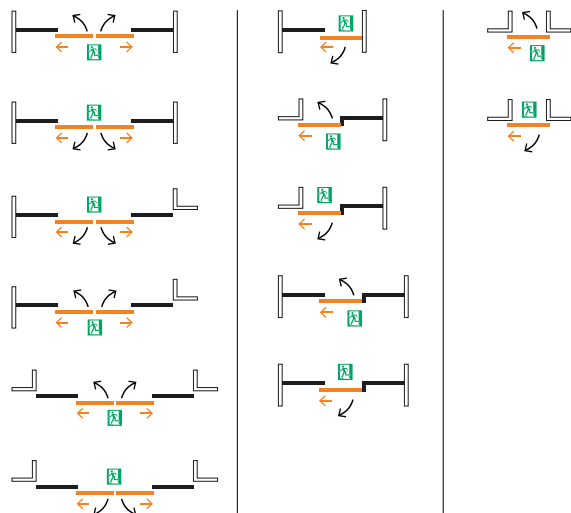

500 EF EI60 | 2L/2S on the wall

Front view

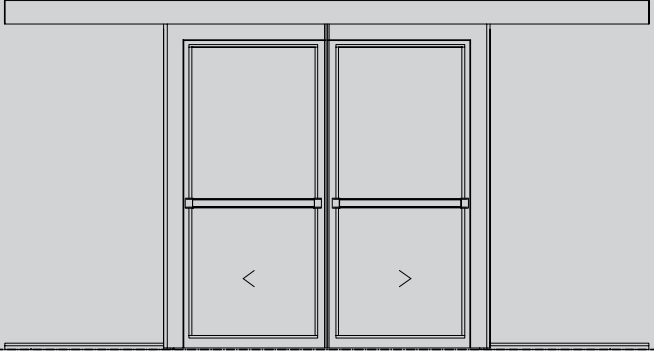

Vertical section view

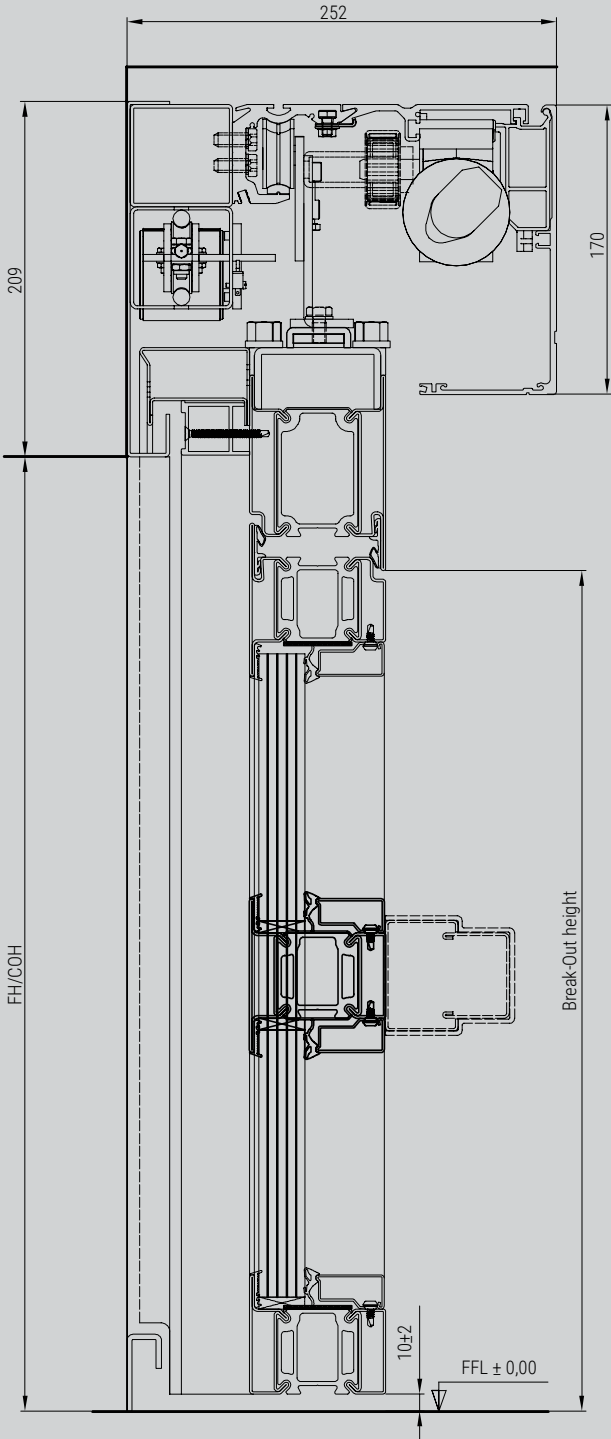

Horizontal section view

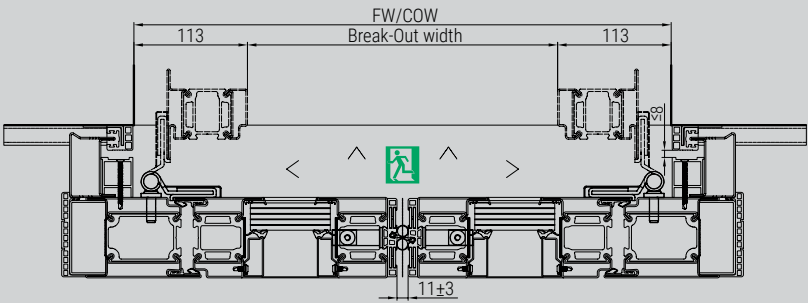



Easy safety rescue



500 EFS | escape fire sliding door

Fire sliding door 500 EFS functions as a standard automatic sliding door that is convenient for hospitals, working places, hotels, shopping malls and other public places where safety is first. Its fire resistant ability divides the two fire sectors on ESCAPE routes. It is constructed for 30 or 60 minutes fire resistant fully expanded, from any side of the door.

In case of an emergency, fire alarm or power failure, the mechanical spring system closes the door, which then in a few seconds, transforms into a swing door. Safe evacuation is provided by swing opening, that self-closes after that.

A swing opening is provided in the escape direction by pushing the door. On the opposite side of the door, in the rescue direction, the door simply opens by pulling the door with a flush handle.

The swing opening provides a safe rescue of people and goods out of the danger zone. In case of a fire expansion, the door creates a safe barrier that stops the flames and heat from spreading to the safe side.



EXIT











Technical data | 500 EFS

USE	interior/exterior for escape routes
DRIVE	height: 170 mm
DIMENSIONS	1 leaf: clear opening width 800 - 1400 mm clear opening height 1900 - 2500 mm 2 leaves: clear opening width 1600 - 2500 mm clear opening height 1900 - 2500 mm
WEIGHT	max. 300 kg per sliding leaf
FIRE RESISTANCE	EI30, EI60
OPENING - CLOSING SPEED	0.3 - 0.7 m/s (adjustable)
OPENING TIME	0 - 15 s (adjustable)
POWER CONSUMPTION	30/300 VA
LEAF	GLASS: EI30: 15 mm, EI60: 23 mm PANEL: EI30: 26 mm, EI60: 38 mm
INSTALLATION	wall installation
PROFILE COLOR	RAL color
GLASS COLOR	fire safety transparent glass
DOOR OPENING	sensor, smartphone, switches, access control
SWING OPENING VARIETY	PUSH to open, flush PULL handle
SECURITY	infrared-microwave activation sensors
FUNCTIONALITY	side safety sensors a variety of adjustable functions and parameters switching between different door regimes: OPEN, LOCK, STOP, AUTO-SUMMER, AUTO-WINTER, ONE WAY-SUMMER, ONE WAY-WINTER warning diagnosis by COM20 connection to fire safety system
EMERGENCY EXIT	✓
ELECTRIC LOCK	included
SELFCLOSER	included
STANDARDS	EN14351-1, EN14351-2, EN16034, EN16361, EN16005, DIN18650, EN179, EN1154, EN 13501-2, EN 1155



PUSH to open

Flush PULL handle



* S = sliding leaf, L = leaf, FW = frame width, FH = frame height, COW = clear opening width, COH = clear opening height, UW = Unit width, X = distance

Version possibilities

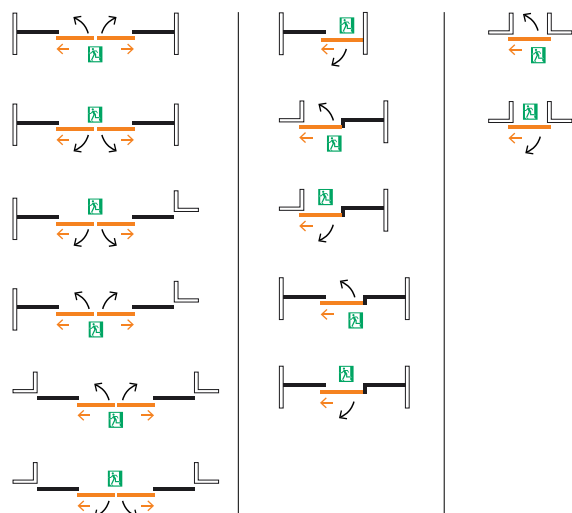

500 EFS EI60 | 2L/2S on the wall

Front view

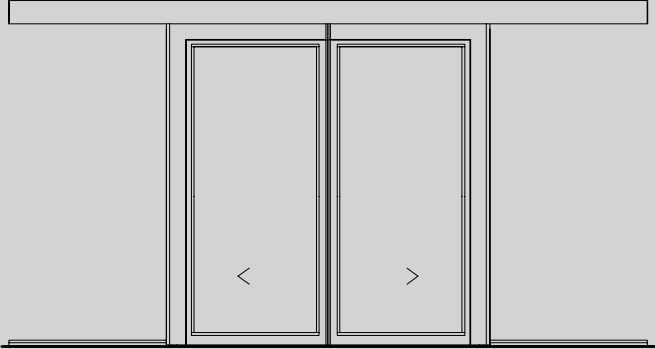

Vertical section view

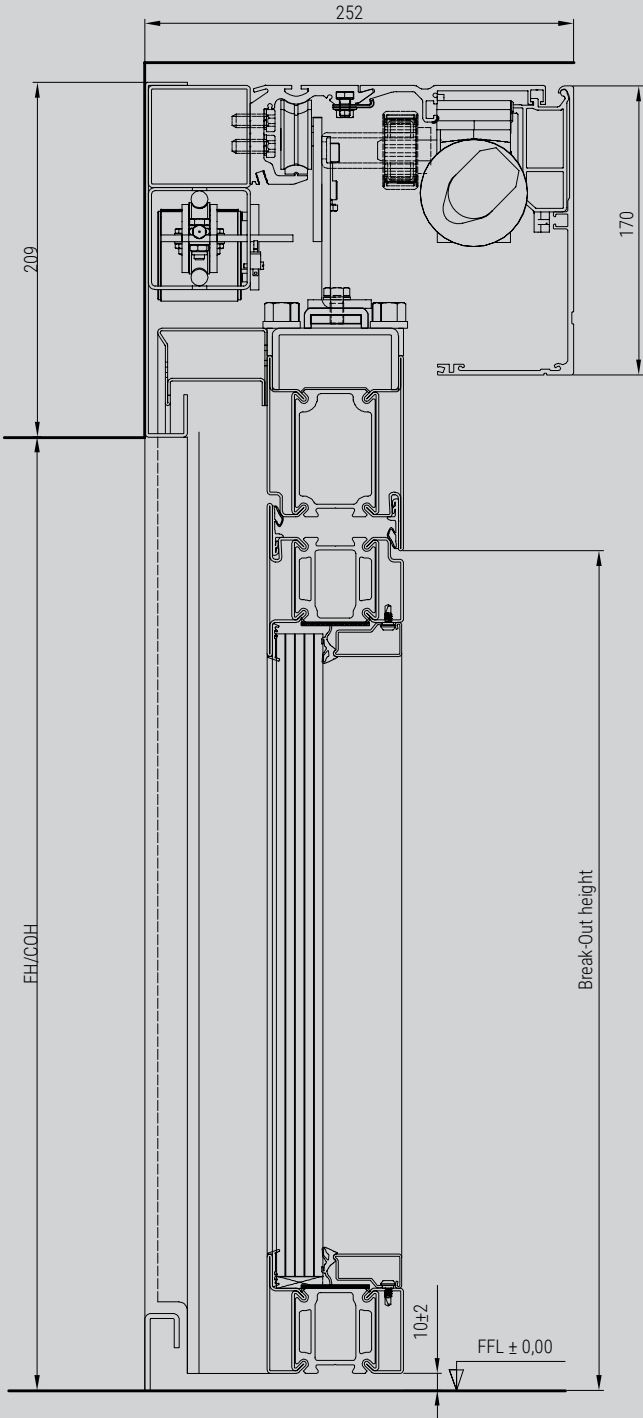

Horizontal section view

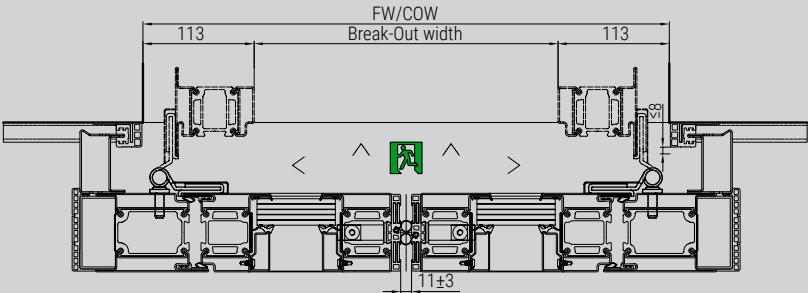

Customize your door

Choose your assembly, choose your function

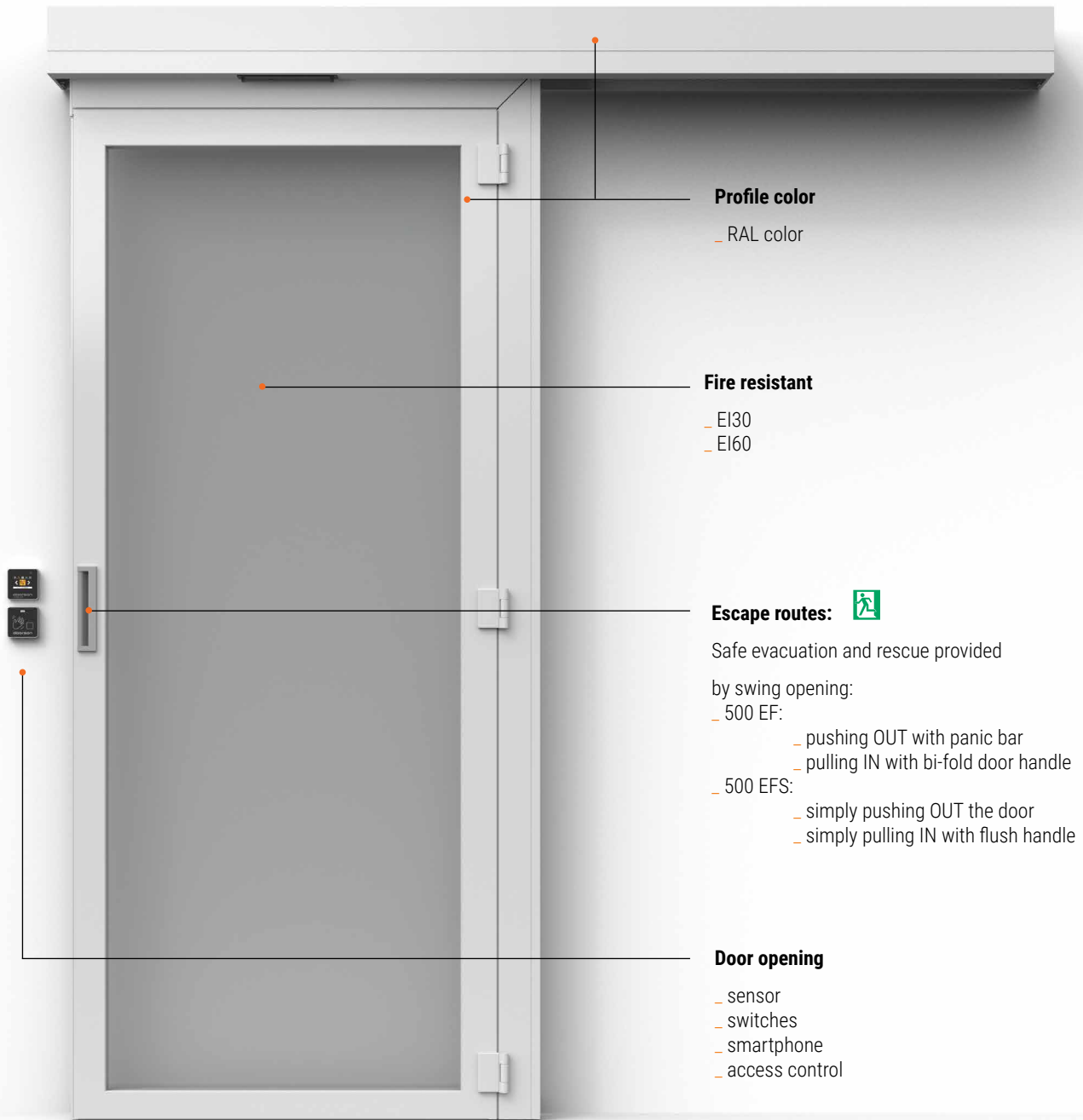

Profile color

- RAL color

Fire resistant

- EI30
- EI60

Escape routes: 

Safe evacuation and rescue provided

by swing opening:

- 500 EF:
 - pushing OUT with panic bar
 - pulling IN with bi-fold door handle
- 500 EFS:
 - simply pushing OUT the door
 - simply pulling IN with flush handle

Door opening

- sensor
- switches
- smartphone
- access control

1. Door installation

The doors can be installed on the wall. Combine your system with a flexible, rigid or partition wall.

Available on
Door calculator

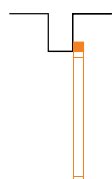

On the wall

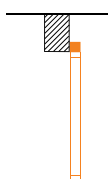

Flexible wall

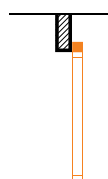

Rigid wall

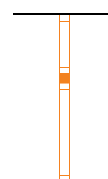

Partition wall

2. Leaf

The drive can be combined with door leaves that can be made from different frame profile systems.



EI30

VA THERM fireproofed isolated steel profiles, with laminated fire safety glass: 15 mm



EI60

VA THERM fireproofed isolated steel profiles, with laminated fire safety glass: 23 mm



Panel solution

Fireproofed isolated steel panel
EI30: 26 mm
EI60: 38 mm



Door opening

Choose your access. Select the best opening possibilities.

SENSOR



Side safety sensor protects the opening path from both sides of the leaf. ToF sensors scan the human body and rapidly increase the level of safety.

Sensor detection

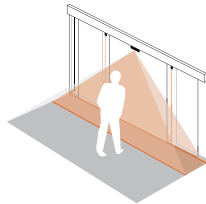

Mounting heights of up to 3 m. Detect people and objects in a range up to 2.5 m.

Sensor installation

Suitable for different types of applications.

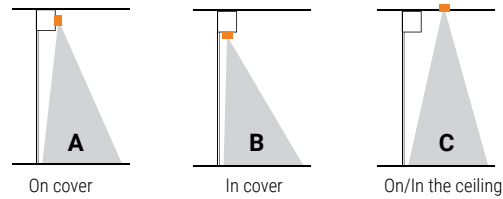

Sensor is the key element to moving the door. The detection area activates the door to open, while the safety area provides pedestrian safety when the door is closing.

DOOR SWITCHES



COM 20 | touchscreen switch



COM 21 | mechanical switch



SMART SWITCH | touchless opening



SMART LOCK | touchless opening and locking



EMERGENCY SWITCH | open/close



CLOUD GATEWAY | access control

SMARTPHONE CONTROL



Control your system remotely 24/7 with the mobile app **Door Cloud**.

Door Cloud

The door mobile app enables you to change door regimes, take a look at the statistics and reset the parameters. Receive notifications, warnings and always be up to date.



Privacy



Access control



Control centre



Notifications



Calendar



Wireless

ACCESS CONTROL



Card reader
Access controller with an integrated card reader.



Card reader with keypad
PIN code access control.



Remote controller
Remote controller for distant door opening and closing



First opening switch
One time entrance key opener SE-1 or a built-in wall SE-2.

Escape opening possibilities

In case of an emergency, 500 EF and 500 EFS doors transform into swing operation. They provide a simple **ENTRY** into the danger zone, which ensures the safe rescue of people. The doors also provide a simple **EXIT** out of the danger zone, therefore enabling a safe escape route. The doors can be assembled with different handle options that provide different functionalities.

500 EF opening option



Panic PUSH bar



Bi-fold PULL handle

500 EFS opening option



PUSH to open



Flush PULL handle



Fire switch

Fire switch is a fire door functional display that presents mode of operation: normal operation, fire operation and escape direction.



Normal operation



Transforming operation



Swing opening escape direction



Swing opening opposite direction

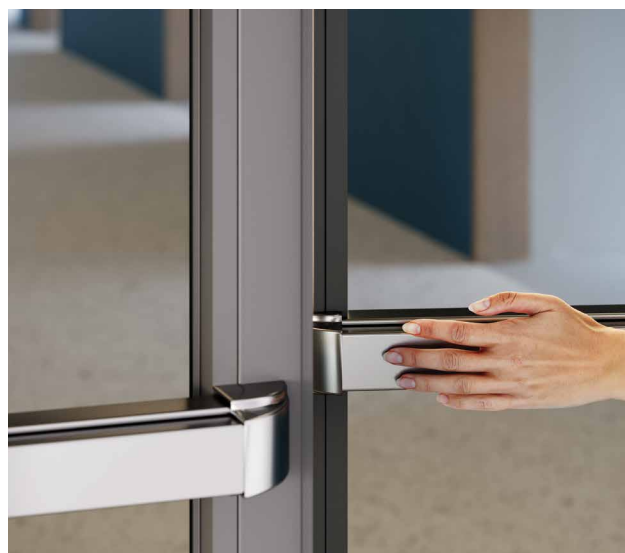

In case of fire

Reducing risk, saving lives

A fire can occur anytime and anywhere, so it is extremely important that you are well prepared for anything.

The consequences can be devastating and even though you cannot prevent the fire from happening, fire doors can help you limit the damage and provide a way out.

fire barrier
prevent the spread of fire

swing
opening
for life saving

No escape

500 F

After the activation of a fire alarm, the sliding door transforms into a safety barrier. 500 F prevents the fire and heat radiation from spreading to the other side.

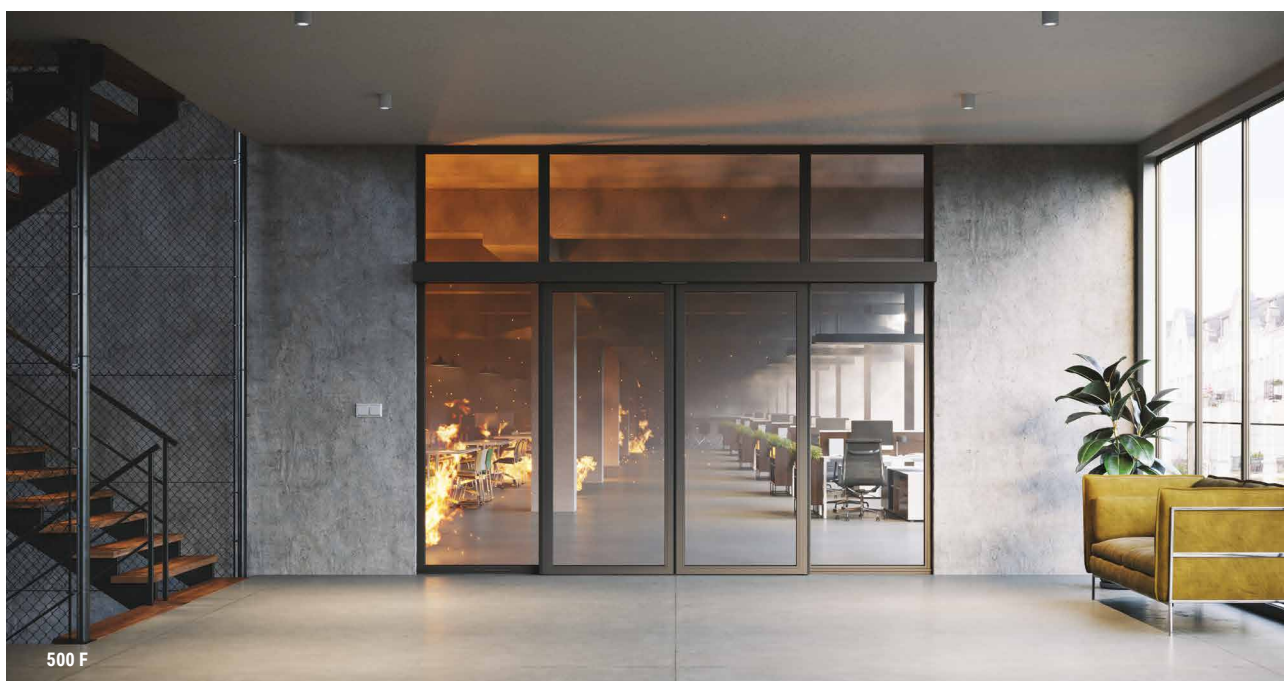

Escape routes

500 EF and EFS



Many forget about the importance of escape routes, because they are rarely used in that way. But they are extremely important, as they provide a quick and safe evacuation route in the event of a fire.

Automatic sliding door on escape routes provides high frequency transition in-out at normal operation. After the fire alarm, people can run freely out of the danger zone. A safe rescue is available.



Develop, test, certify

Innovative ideas, latest technology, stylish design

We are developing our doors with passion. True ideas are the key for creating something really new. We look for a challenge in every new task. We believe that every problem has a solution and that the effort pays off when you reach the final result. We always try to find balance between clean design and functionality.

The latest technology, IoT smart technologies and digitalization that we integrate into our doors provide smooth operation, redundancy, fire safety and safe operation. Moreover, it is easy to use and learn. All inside our verified advanced door solutions.

Product lines 500 EF and 500 EFS are the result of our very own invention.

100%
certified

60'
fire resistant

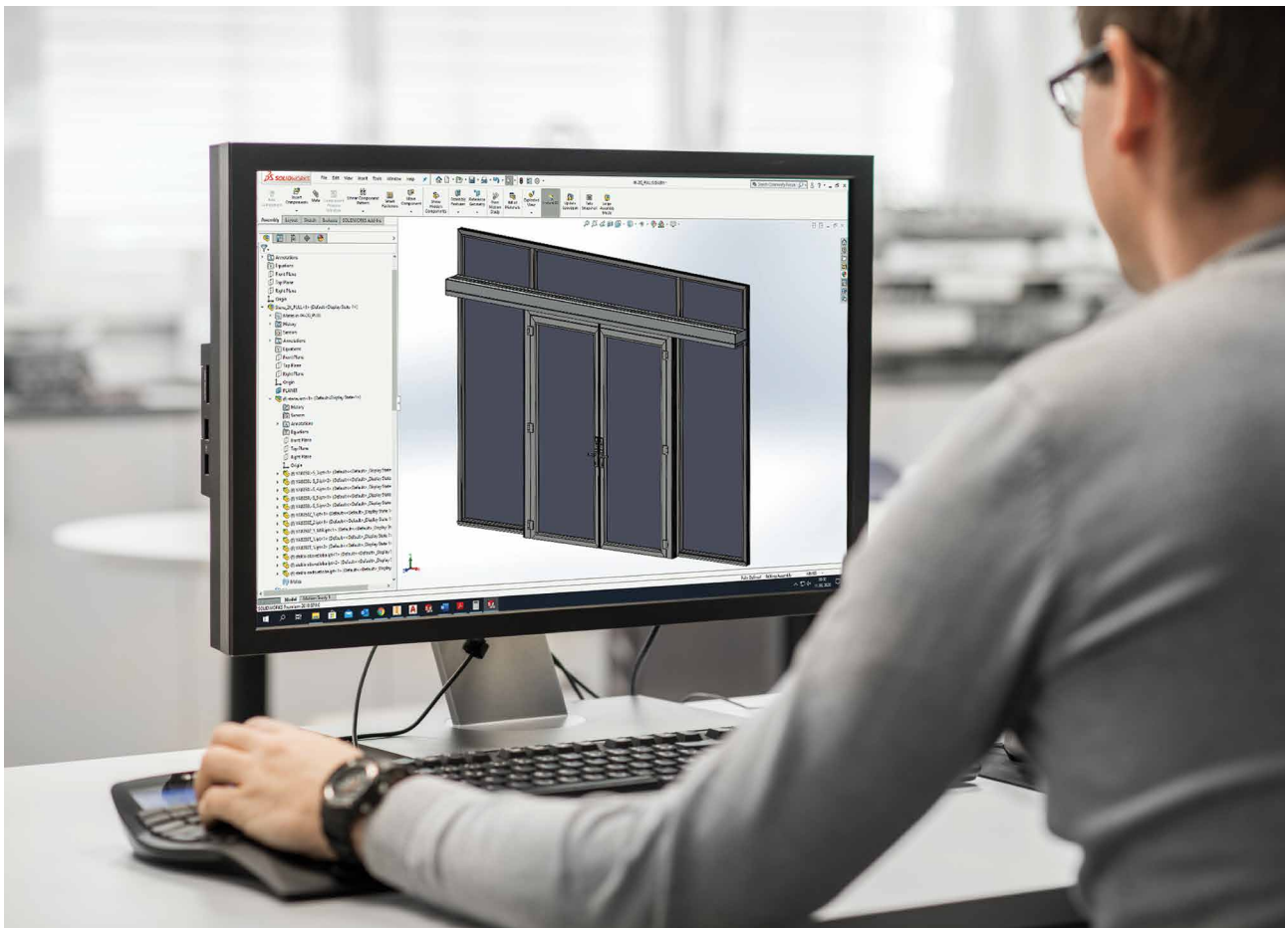



0 minutes



20 minutes



40 minutes



60 minutes

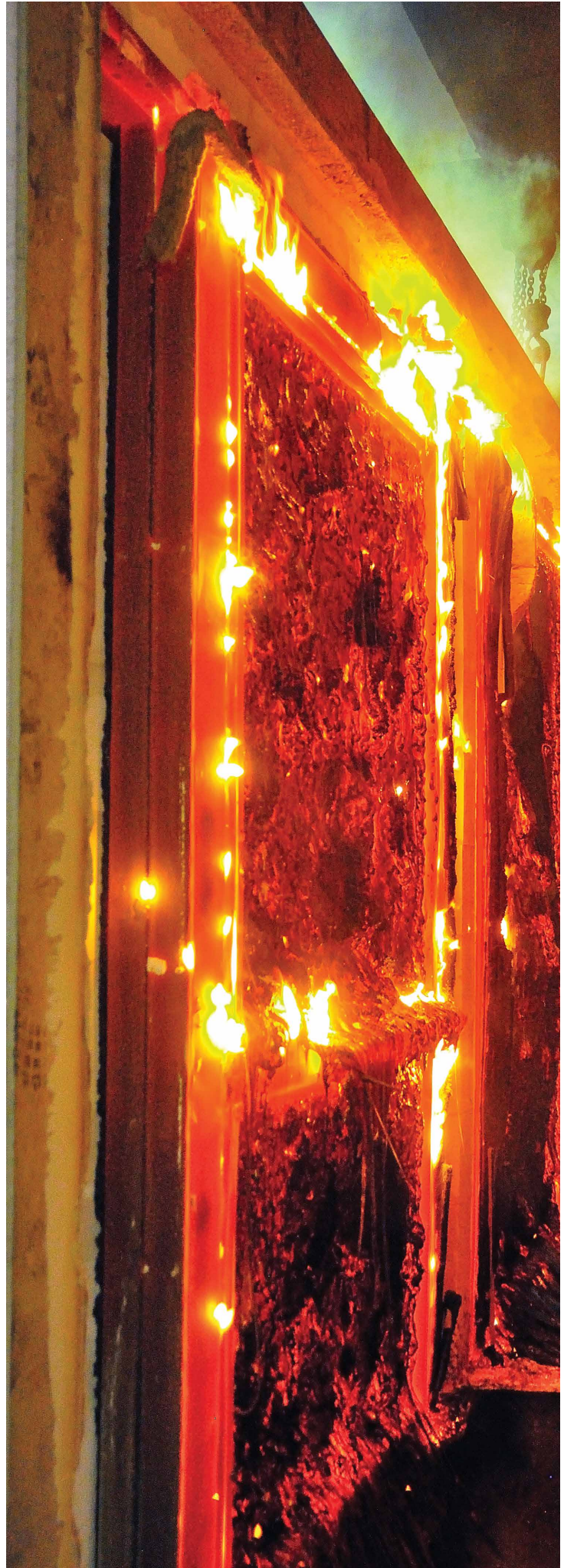

Additional **information** —→

Door switches

For best user experience

Doorson puts a strong emphasis on innovation, a unified design and functionality. Developing the door switches family from the beginning till today is something that makes us special. Automatic sliding doors can be combined with different sets of operational switches. Our switches are multifunctional and provide many user made combinations.



You can switch between different door modes:
OPEN, LOCK, STOP, AUTO summer, AUTO winter,
ONE WAY summer, ONE WAY winter.

Choose the right door switch for the right application.
With it you can easily control your door and customize
the functionalities.

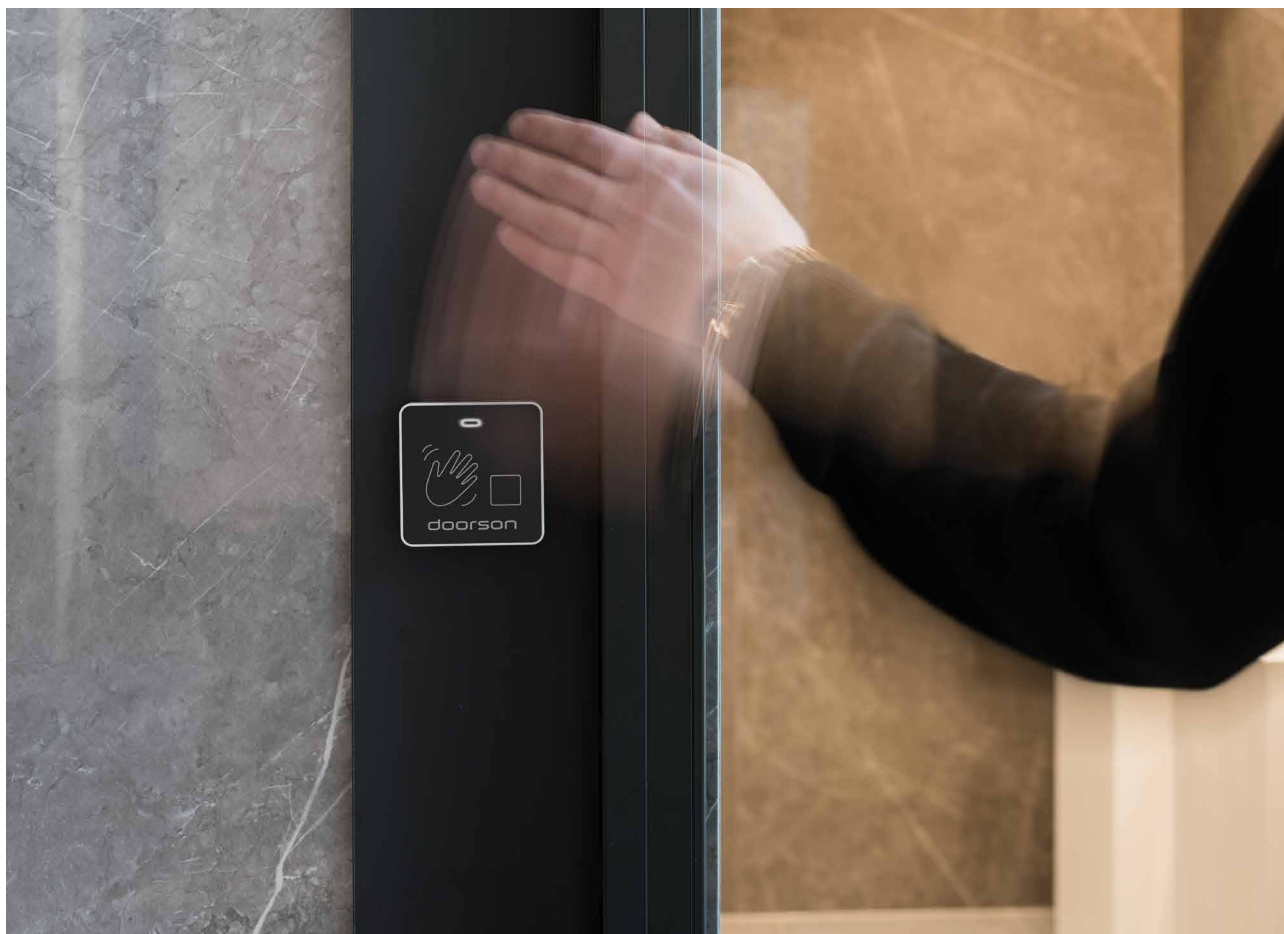



COM 20 | touchscreen switch

Multifunctional touchscreen switch mode operator offers different settings, door parameter management, display warnings, errors and diagnostic management.



COM 21 | mechanical switch

Mechanical switch mode operator with 7 different modes: OPEN, LOCK, STOP, AUTO summer, AUTO winter, ONE WAY summer, ONE WAY winter.



SMART SWITCH | touchless opening

Multifunctional touchless opening with adjustable sensor detection 0.2m – 1m: NARROW, MIDDLE or DEEP.



SMART LOCK | touchless opening and locking

Multifunctional touchless opening and locking with three operation modes: OPEN, LOCK and AUTO. Adjustable sensor detection 0.2m – 1m: NARROW, MIDDLE or DEEP.



EMERGENCY SWITCH | open/close

For the use on escape routes, emergency exits, fire doors and other safety reasons with light indication. Emergency open for standard door and escape door. Emergency close for fire doors.



CLOUD GATEWAY | network management

Doors are connected by cloud gateway on network to DOOR CLOUD management. Web application providing door control and door management. Three different levels access as administration, service, end user. Door management is provided as control, errors, warnings, users, calendar. IoT functionality is integrated.

Touchless opening

Clean hands with a contact-free door opening

We make doors that provide a hygienic and comfortable opening. An entrance with a touchless door is a great benefit for every user. You can choose between a sensor or touchless switch.



Standard
access
control

Door cloud
& IoT

Local cloud

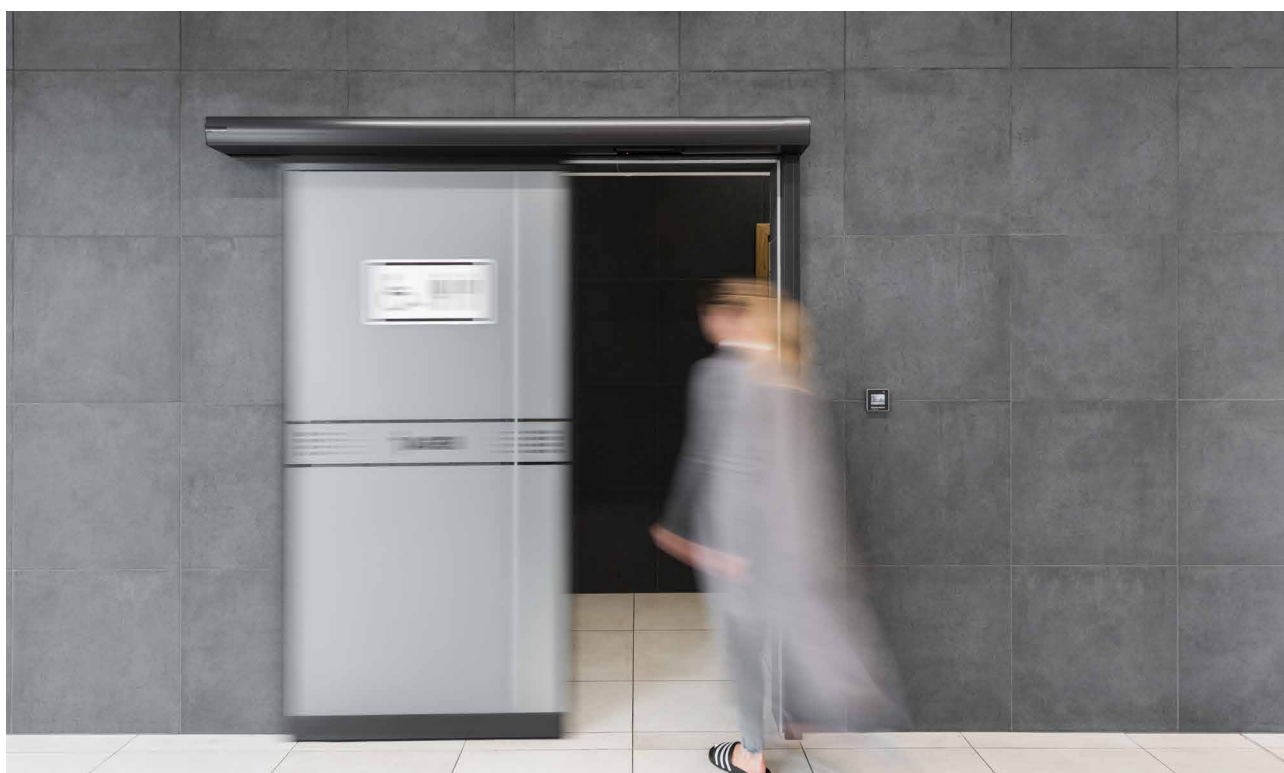

Smart Switch & Smart lock

Our Smart Switch and Smart Lock enable a controlled door opening that can be used in many cases and is easy to install. You can open the door by approaching the body, arm or hand, otherwise it'll stay closed. The choice of opening the door with the help of a Smart Switch is very convenient in narrow passages, where a door with a sensor would often open unnecessarily. They enable a wide range of applications like office, restroom, restaurant or healthcare facilities, where hygiene is very important. You can use Smart Switch or Smart Lock to selectively open the door. Adjustable accurate depth measurement allows you to open the door by entering the detection zone. In the corridor, you can pass the door and it will not open. But when you enter the zone, the door will be open.

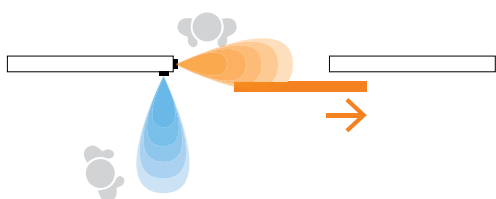

Don't touch the handles, minimize the risk of infection.

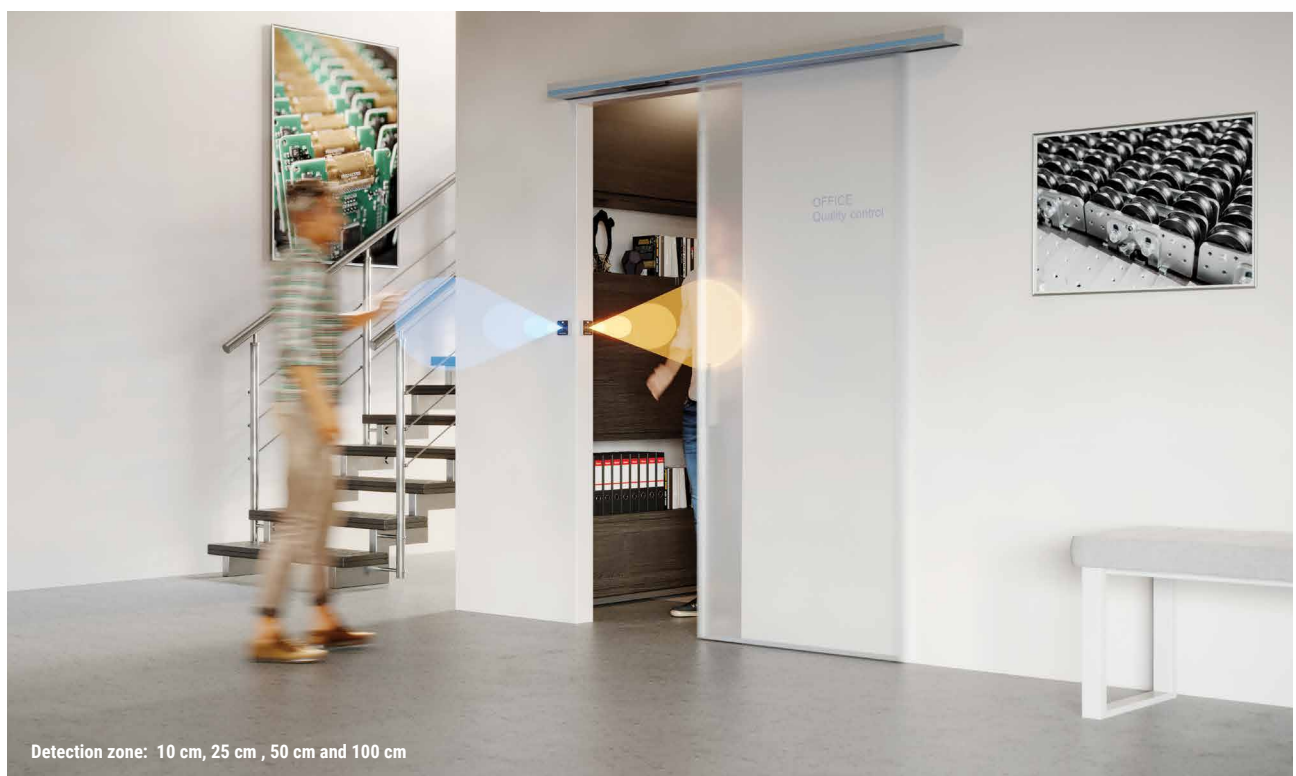

Detection zone: 10 cm, 25 cm, 50 cm and 100 cm

Remote control

Access anytime, anywhere

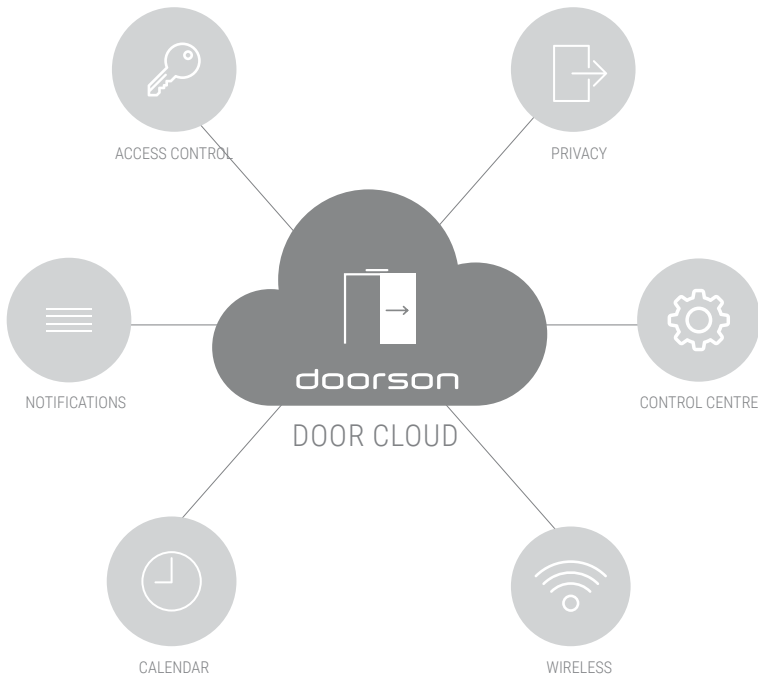

Control your door system remotely. Doors are connected online and you can receive all information about what is happening with your system anytime and anywhere, 24 hours a day, 7 days per week.

Upgrade your door by using Door Cloud. Connect by mobile application, receive information about your door, use IoT functionality.



24/7
access



30%
cost savings



Security
safe connection



Full
door control

The door mobile app allows you to change door modes and functionalities. Use your smart device to adjust your doors, read the statistics and set the parameters. And that is not all - you also receive notifications and warnings.

Controlling your doors has never been so easy. All you need is a smart device and Internet access.

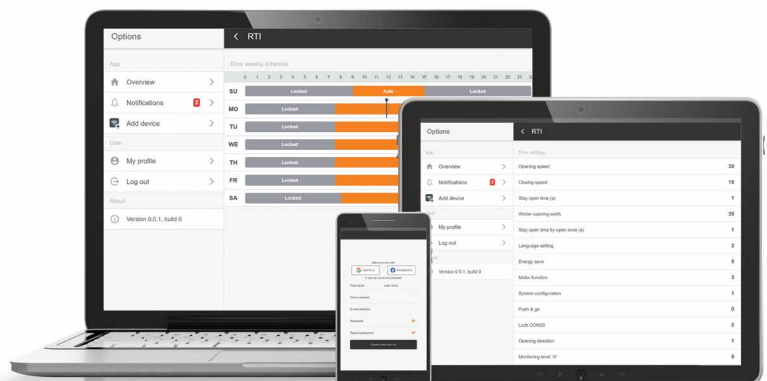

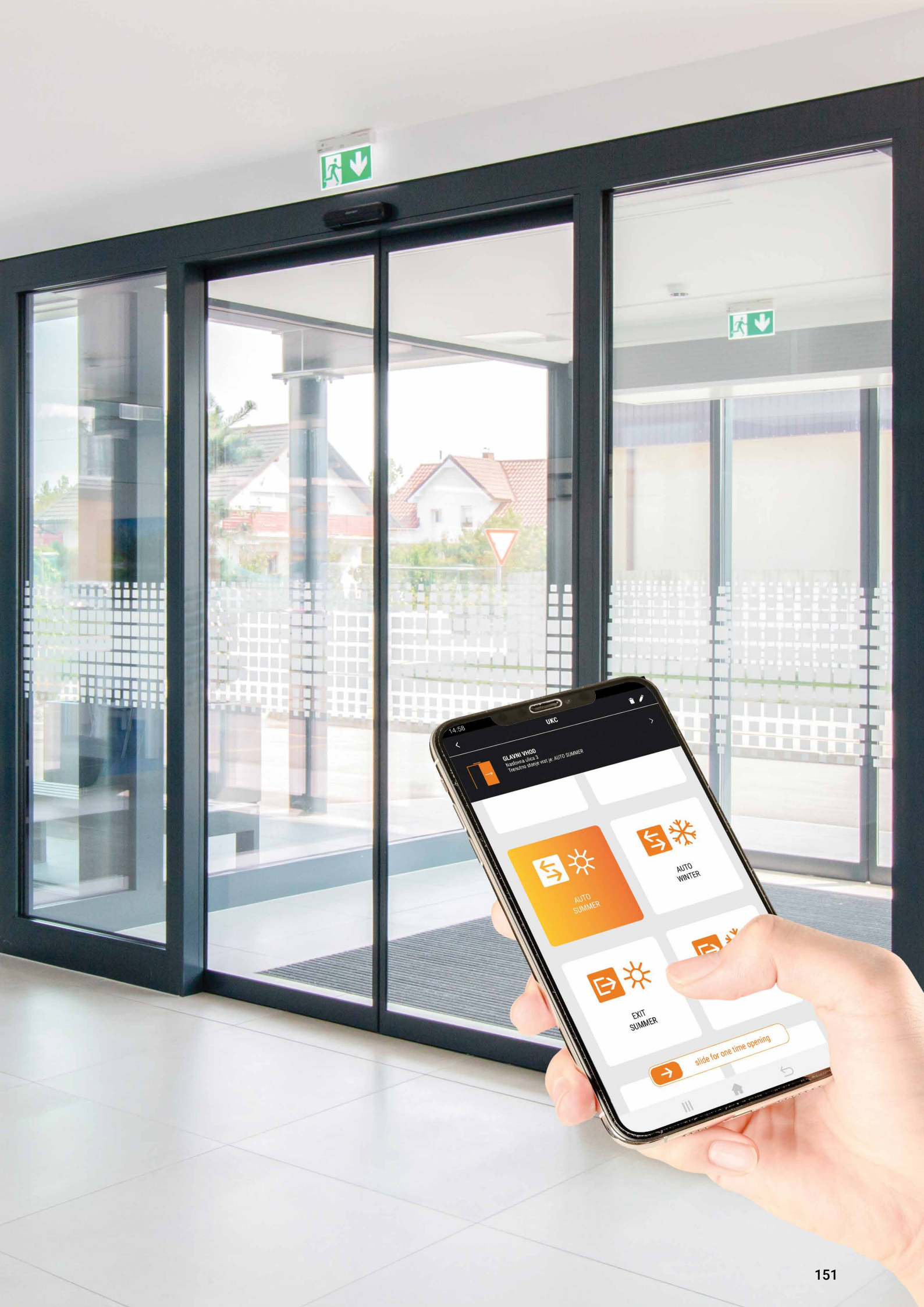

Save energy

Innovative energy solutions that contribute to saving the globe

Our philosophy is to produce highly energy efficient doors. We are fully aware that today's comfort leads to energy consumption.

70%
saving energy
and reducing CO²

< 0.5 W
consumption

Electric save - active save

Consumption <0.5W

Whenever the doors are still, in closed or open mode, the door controller falls in save mode, while energy consumption drops to 0.4 Wh, compared to other doors on the markets that use 20 - 30 Wh. In save mode the sensors, program switches and other electrical accessories fall in save or switch off mode.

PFC power factor correction 0.98

All electric consumers work on 0.60 efficiency on average. Low efficiency means more energy is consumed, more production, bigger power plants need to be built, a stronger network has to be provided. In today's world, there is around 40% loss, which creates a big opportunity. Our Door Controller works with electric power factor correction, and the result is PFC=0.98, which means only a 2% loss. We are proud to be one of the first.

AVERAGE FUNCTIONING OF AUTOMATIC SLIDING DOORS WITHIN ONE YEAR

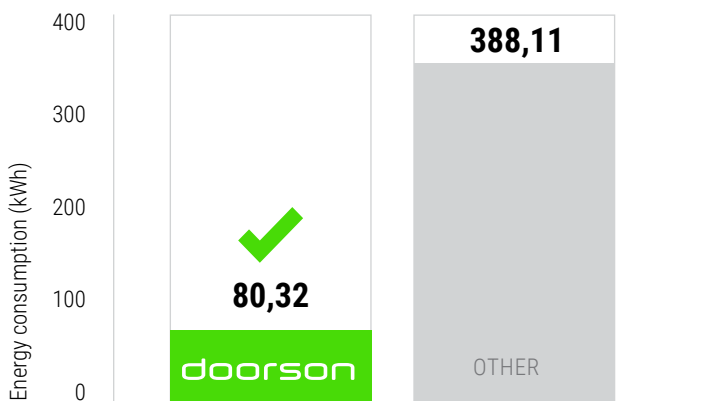

social
responsibility

sustainable
development

cost saving

health
and safety

save our
planet

Thermal insulation - passive save

A highly efficient automatic sliding door system is constructed from thermally broken profiles, isolating material, gaskets, pressure expanding strips and highly insulated triple glass. Thermal insulation values for standard size doors reach a thermal transition lower than 1.0W/m²K in compliance with all relevant standards and directives. Air tightness plays an important rule as well.

With energy save products we do not just save the globe, but also cut the costs of energy that pay off your investment.

< 1.0 W/m²K
thermal insulation

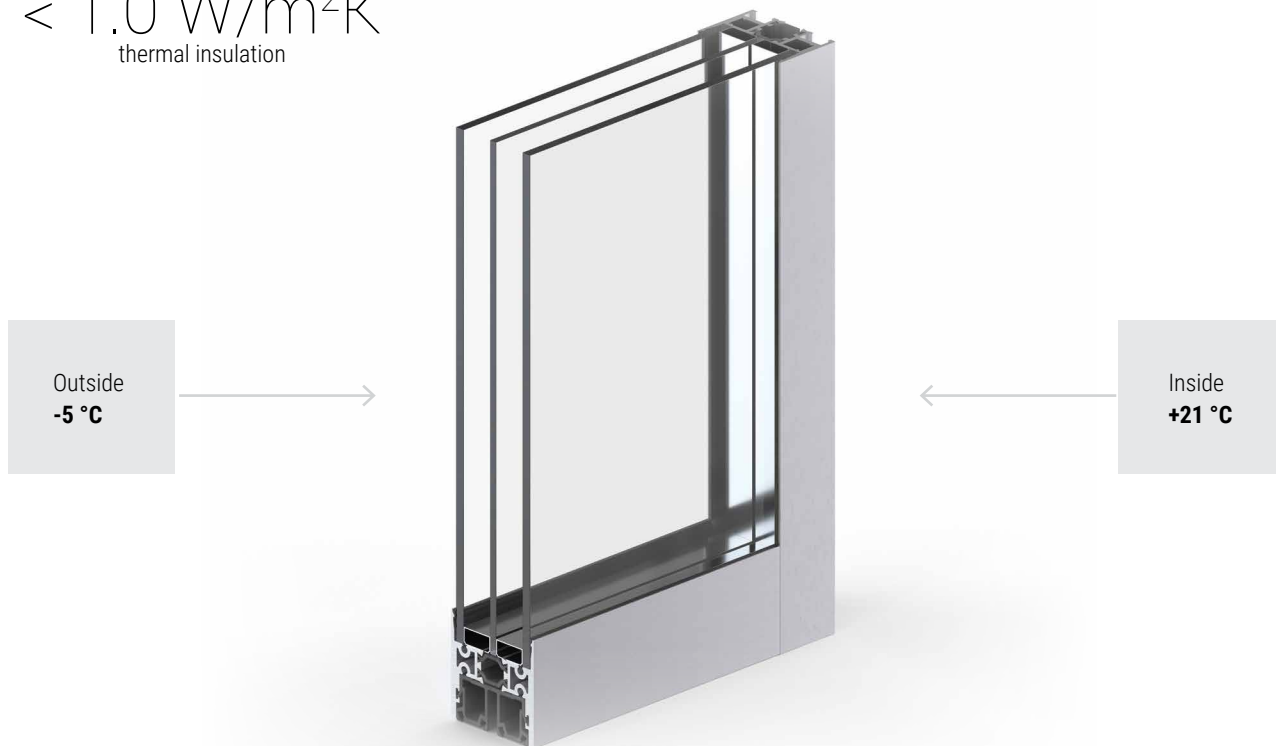

Passive energy saving

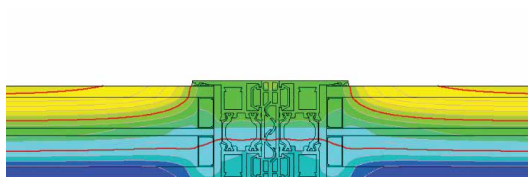

Thermal break system closing leaves, bottom section

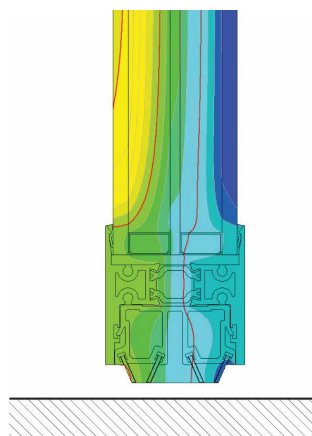

Thermal break system side section



Escape routes

Safe evacuation for everybody

Ensuring a safe evacuation in emergency situations is extremely important, especially when it comes to public buildings, where a large number of people are present. Automatic sliding doors on evacuation routes offer a comfortable everyday use, but at the same time ensure a safe evacuation in emergency situations. For the installation on evacuation routes you can choose between REDUNDANCE, BREAK-OUT and FIRE ESCAPE doors.

Redundant

A redundant door drive differs from a standard door drive by integrating two motors and two controllers, with battery and a watch dog management security system. Upon the activation of a fire signal, power failure, door malfunction or if the network power is cut off, the sliding door automatically opens and stays open, unless it is in "locked" or "stop" mode. Doors on evacuation routes are always fitted with an emergency switch that is close to the door and provides an emergency opening.

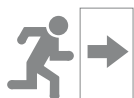
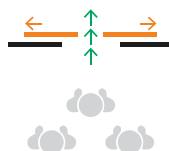

emergency
exit
for safe evacuation

All automatic sliding doors product line 300 are available in the redundant version.



Standard break-out

On evacuation and escape routes you can also use automatic sliding doors that provide a mechanical evacuation. They function as standard automatic sliding doors, but with a special break-out performance. A sudden pressure on the leaves transforms them and they open as swing doors. This provides an easy evacuation through the whole width of the doors. Both sliding and fixed leaves function as a break-out door.

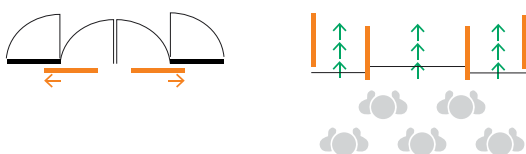

Fire break-out

On evacuation and escape routes you can also use automatic fire sliding doors that provide a mechanical evacuation. They function as standard automatic sliding doors, but upon a fire alarm, they transform into swing doors. This provides an easy evacuation through the door leaves.



Digital transformation

Virtual reality

Doorson TOOLS enables effective working for partners.

With the digitalization of all processes within Doorson, we want to interconnect the business model of innovative technology with a successful customer approach, create a new culture of work with digital tools as well as educate our staff for a more sophisticated, effective and transparent work.

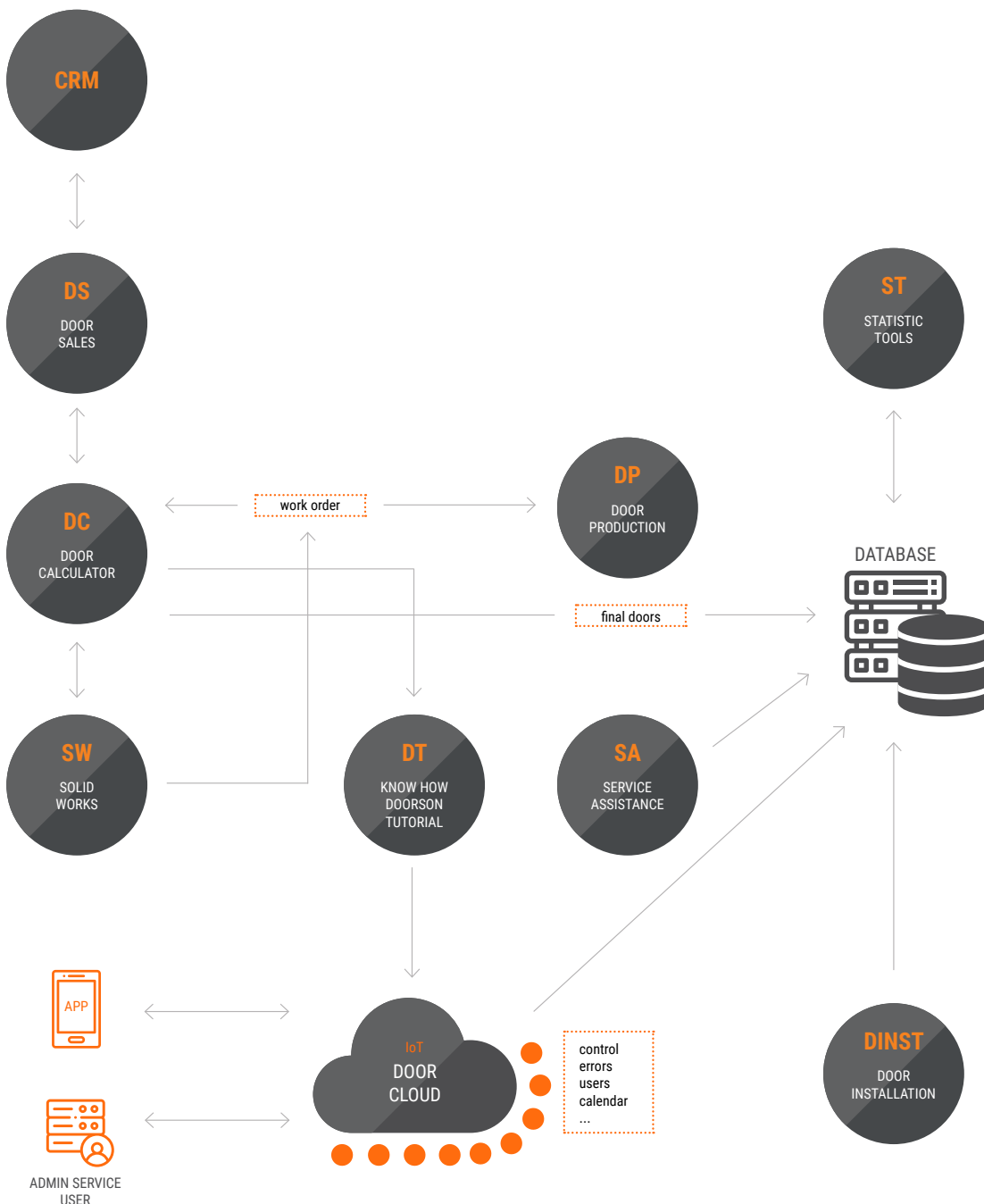

Door Calculator

Door Calculator is an online tool that enables a quick access to all our door features. It allows the creation of different combinations, offers an automatic output of technical data, a 3D model drawing, and price according to the chosen elements, as well as providing the possibility to place an order.

Door Sales

Door Sales is a web-based application that enables a fast and easy step-by-step creation of an offer. With it, we can trace the activities of our partners, which leads to a more effective co-operation and reduces the need for support activities.

Door Service

Door Service is an online tool, intended for the maintenance support of automatic sliding doors. On one hand, the app allows the maintenance manager to effectively allocate employees, and on the other, the service technicians can communicate more easily, see the available vehicles, schedule customers and have a complete overview of the material.

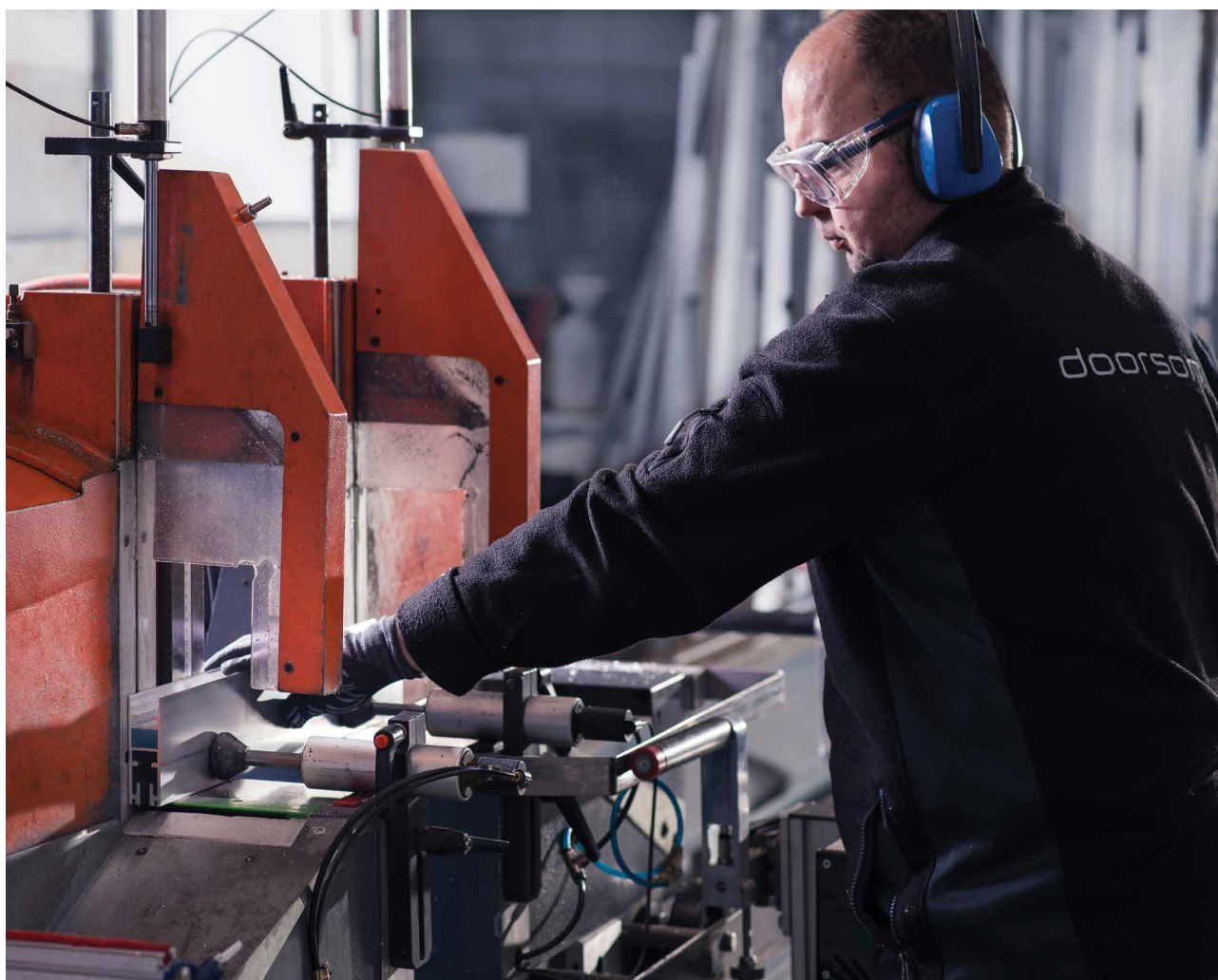

Door Calculator



Configure your door

Our Door Calculator is an online web app that provides a quick, simple, visual and accurate customization of the door. Regardless of your profession, you can customize your door wherever and whenever needed.

The Door Calculator provides a regular configuration, guides you through logical steps by choosing combinations inside product families, while a 3D visualization at the end shows you the concept that you have chosen. Receiving an offer has never been this easy.

All information is available in one place, so you will not have to study technical brochures and waste your time.

100%
personal assembly

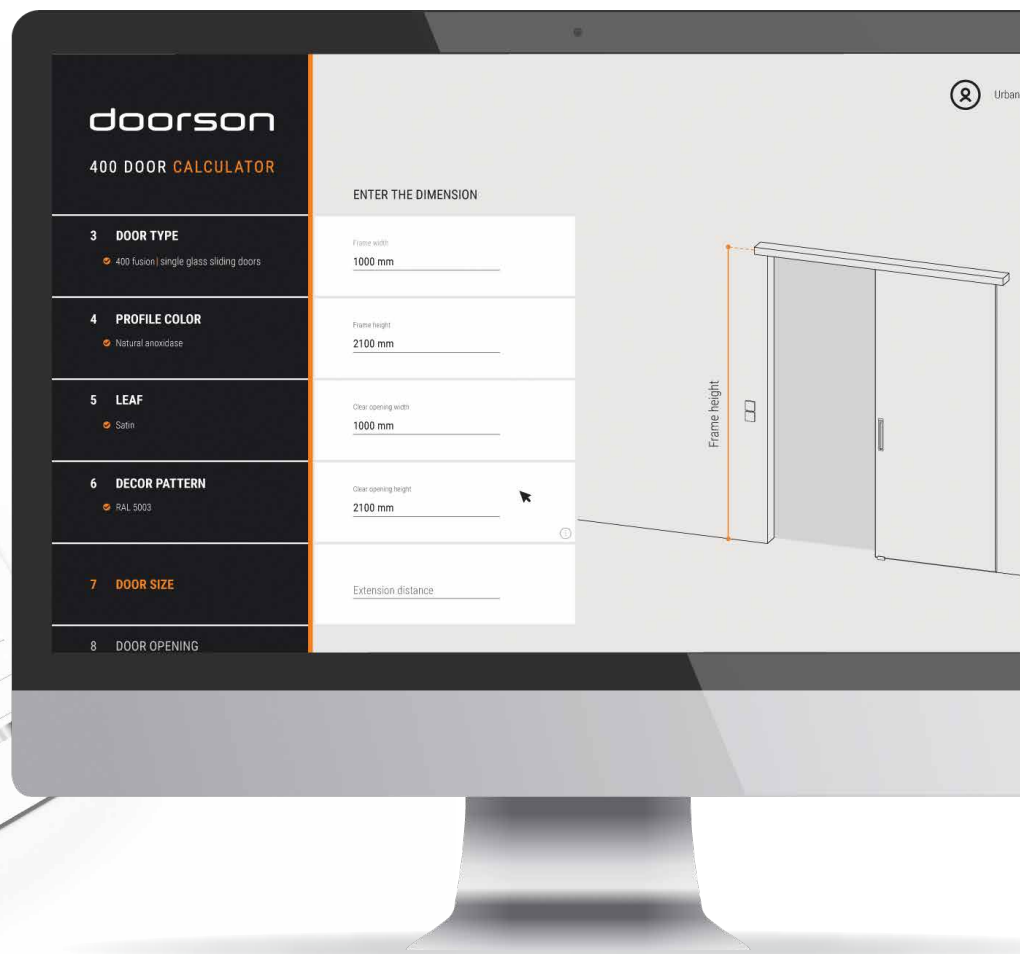
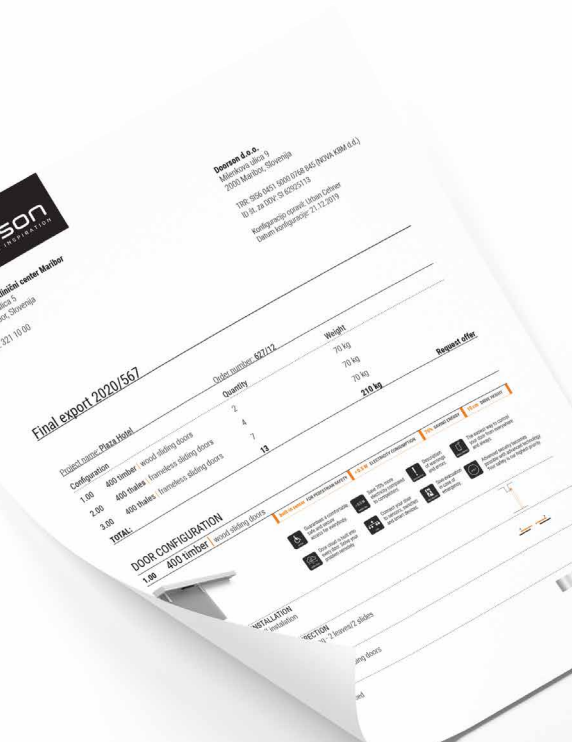

Support Consulting Planning

At Doorson we strive to provide quality consulting and best planning for our customers. We are aware of the importance of your projects, so we help you choose the most suitable product and help you to reach your final architectural solution.

We provide our customers all the information about which door type is the best solution for their project. By consulting we also learn about new approaches, trends and demands in architecture.



Impressive results can be achieved by working together.

Service, maintenance & support

Get help anywhere and anytime

Our experts provide strong technical support and perform a skilled human approach. We support our clients and put a big focus on the aftersales.

For that reason we will continue to invest more time and money in our profession, in order to create satisfied customers.

efficient
problem solving

remote
technical support





Our reliable partners need a global connection where they can make choices and also work from wherever they are at that moment.

The online app tool brings knowledge closer and provides support. We put great emphasis on a strong relationship between a client, partner, door system and the maintenance. The door service app provides strong support for your client anywhere and anytime.

Together we can be effective and efficient.

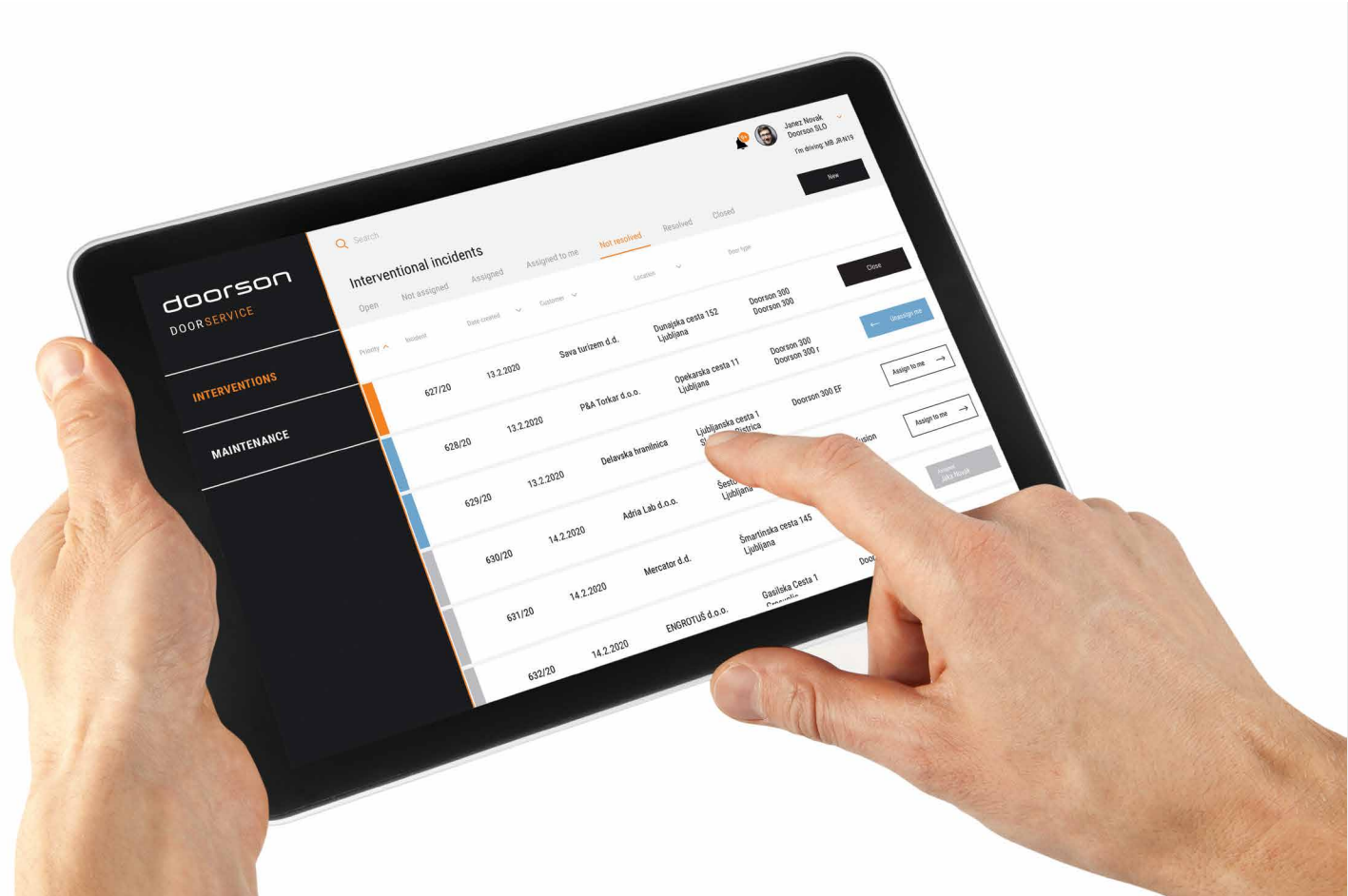

Reference **projects** —→

30 years
of experience

Real life examples

Passion, commitment and expertise. Our products can be found all around the world. Take a look at some highlight projects that impress in architecture, technic and functionality.

As a professional partner for architects, construction companies, building management and end users, we continuously search for new custom solutions.



Coffee bar Bled | architecture: REAL Engineering



EXPANO | architecture: **SoNo Architects**



Hotel A | architecture: **AB objekt**



Franjo Tuđman Airport | architecture: Branko Kincl, Velimir Neidhardt, Jure Radić



Radisson Blue Plaza Hotel | architecture: Raketa



Ban Centar | architecture: Tholos Projektiranje



Car sales Audi, Wolkvagen, Škoda and Seat | architecture: AB biro



Hospital Novo mesto | architecture: Styria Arhitektura



Camping resort Šobec | architecture: Gea Consult



MG Rohr | architecture: Matija Miler



Strojarska Business Center | architecture: Davor Mateković, Tomislav Stojan, Mirna Melez, Ida Ister, Vedran Pavličević

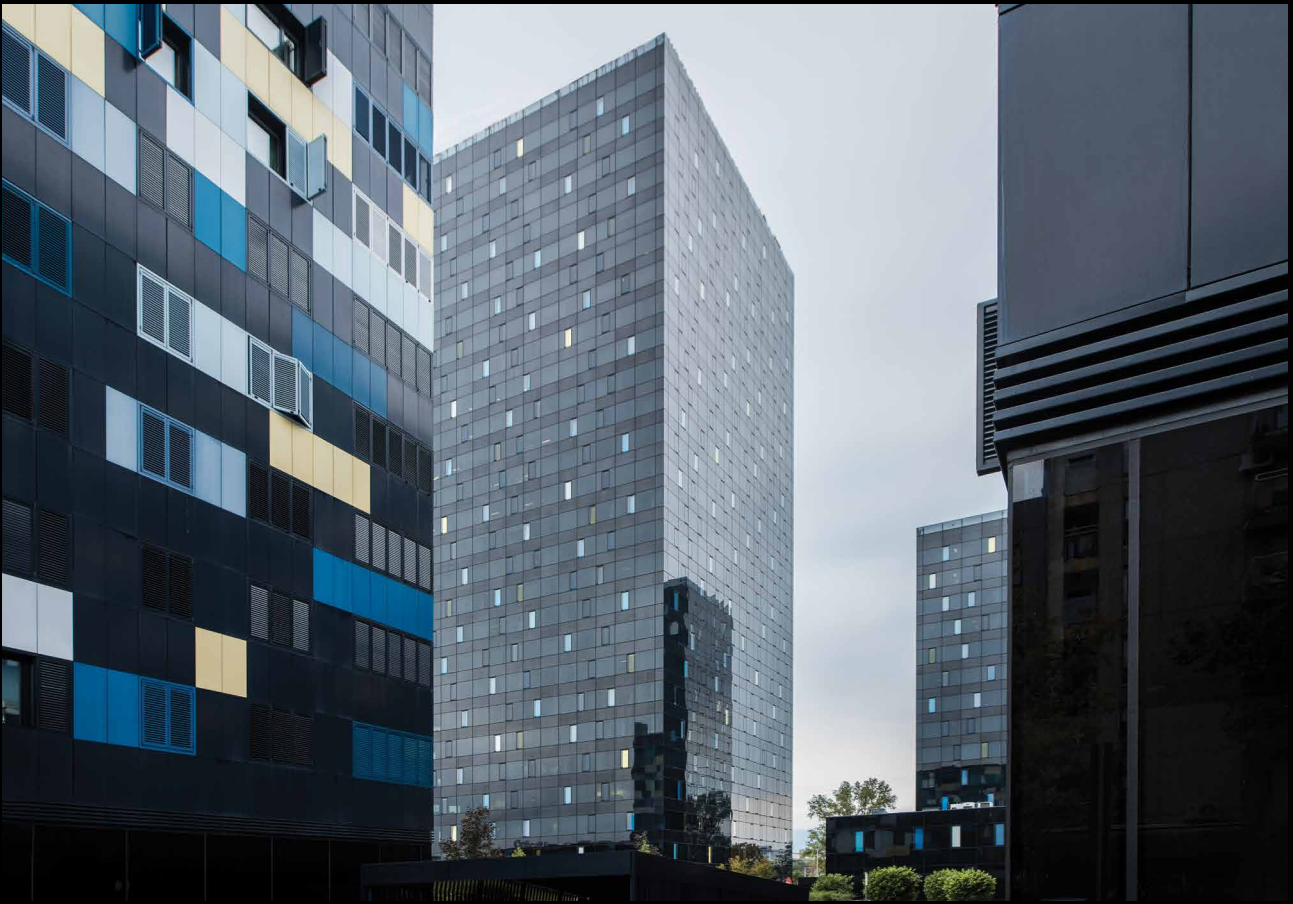

Strojarska Business Center | architecture: Davor Mateković, Tomislav Stojan, Mirna Melez, Ida Ister, Vedran Pavličević

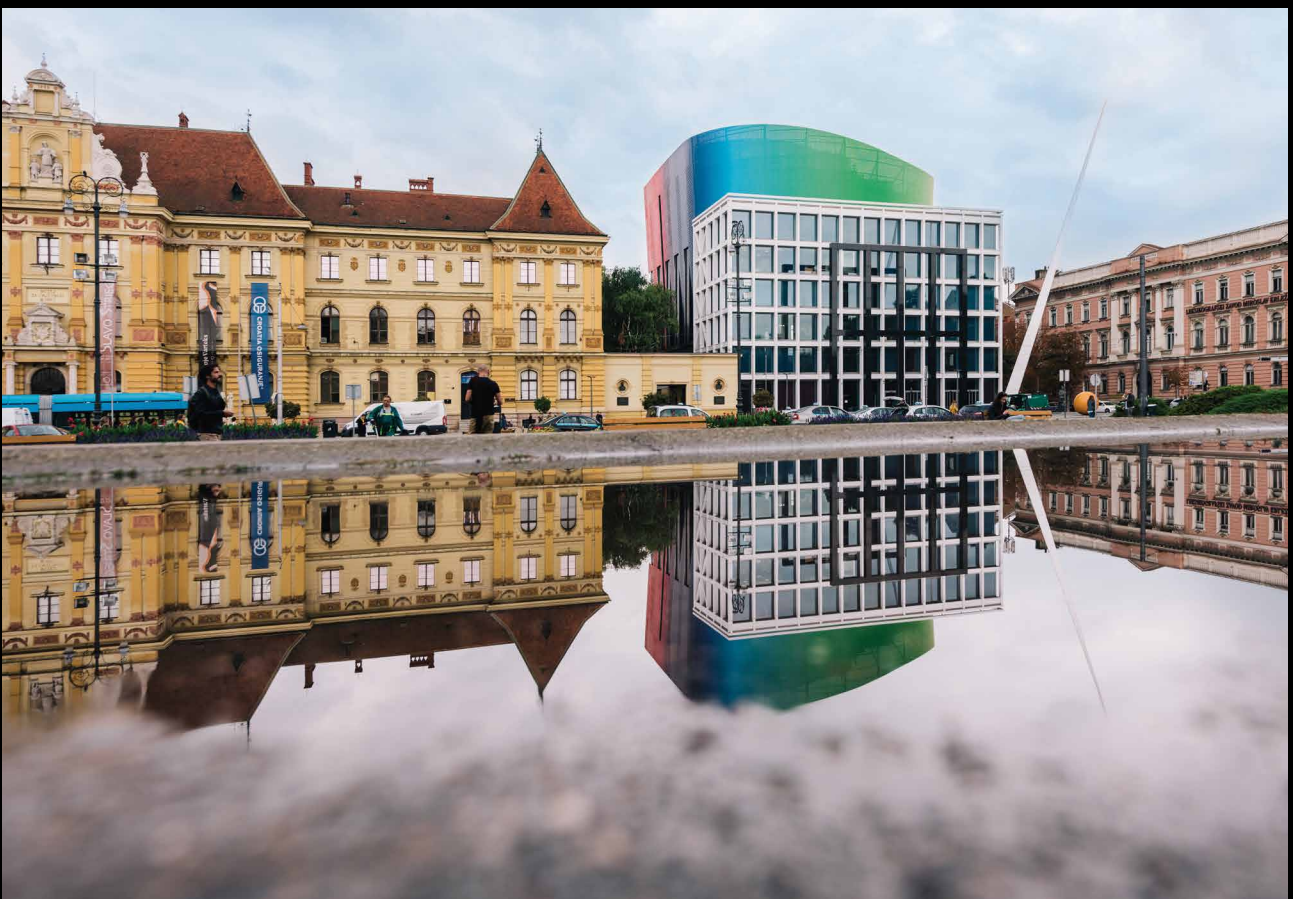

Academy of Music | architecture: Milan Šošterič

doorson



The world changes every day. In order to succeed in the business world, it is necessary to be innovative and global with a powerful team. Inspired by passion, Doorson is doing exactly that.

doorson



Follow us on:



Doorson d.o.o.
Milenkova 9
2000 Maribor
Slovenia

+386 2 460 55 60
info@doorson.com
www.doorson.com



WWW.DOORSON.COM